

PIN OUT	
1	YD
2	XL
3	YU
4	XR

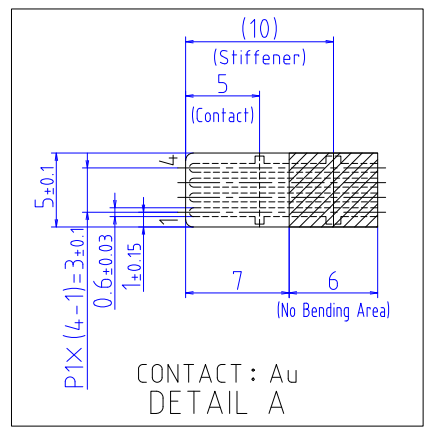

REMARKS	
○ TOLERANCE = ±0.5mm	

ITEM	
1	ITO FILM
2	ITO GLASS
3	TAIL
4	ADHESIVE SHEET
5	PROTECTION TAPE

PART No.	SCALE	DATE	
RST-070WA080A	NTS	Feb/2/2026	
TYPE	UNIT		
STANDARD TOUCHSCREEN OUTLINE DIMENSION DRAWING	mm	DMC Co., Ltd.	

Edges and corners of ITO glass may be chamfered without affecting product specification.