

EM Series Gesture Model  
7" Wide Embedded Panel Computer

# **EMG7**

EMG7-W207A8-0024-x11-01

EMG7-W207A8-0024-107-01

## **Instruction Manual**

## Table of Contents

1.	Introduction.....	4
2.	Notes .....	4
3.	Precautions for safe use.....	4
3-1	Warnings .....	5
3-2	Cautions .....	6
3-3	Handling of LCDs .....	8
3-4	Handling of Touch Screens .....	8
3-5	Handling of SD card .....	9
3-6	Handling of Batteries .....	9
4.	Items Included in Package .....	10
5.	Names of Parts.....	11
5-1	Front .....	11
5-2	Back.....	11
5-3	Right .....	12
5-4	Top .....	12
5-5	Bottom .....	12
6.	External Interface .....	13
6-1	SD Card Slot.....	13
6-2	Serial Port (COM1) .....	13
6-3	Ethernet.....	13
6-4	USB Host Port .....	14
6-5	USB Device Port.....	14
6-6	Audio Interface (LINE OUT) .....	15
6-7	Audio Interface (MIC IN) .....	15
6-8	Power Connector.....	15
7.	Specification.....	16
7-1	General Specification .....	16
7-2	Environmental Specification .....	16
7-3	Installation Specification .....	17
8.	Installation .....	18
8-1	Installation Conditions .....	18
8-2	Panel Mounting.....	19
8-2-1	Panel Dimension.....	19
8-2-2	Installing the Gasket .....	19
8-2-3	Installation Procedure .....	20
8-3	Mounting to a “VESA” Arm .....	21
9.	Wiring .....	22
9-1	Using Accessory Connectors.....	22
9-2	Cautions for Power Supply Wiring.....	23
9-3	Cautions for Grounding .....	23
9-4	Caution for Wiring of Signal Lines .....	23
10.	Inserting and Removing the SD Memory Card.....	24
10-1	Inserting the Memory Card .....	24
10-2	Removing the SD Memory Card.....	25

11.	Connecting and Changing of Batteries.....	26
11-1	Battery Connecting and Changing Procedure .....	26
12.	Applying Protection Sheet .....	28
12-1	Application Procedure .....	28
13.	Calibration .....	29
13-1	Sensor Sensitivity Calibration .....	29
13-1-1	Sensor Sensitivity Calibration Procedure (by switch).....	29
13-2	Coordinate Calibration .....	30
14.	Starting Method .....	31
15.	Maintenance .....	31
15-1	Display.....	31
15-2	Regular Maintenance .....	31
15-3	Changing of Batteries.....	31
16.	Compatible Standards .....	32
16-1	UL Standards.....	32
16-2	CE Marking.....	32
16-3	RoHS Directive .....	32
16-4	FCC .....	32
17.	List of Option .....	33
18.	Warranty and Repair .....	34
18-1	Inquires.....	34
18-2	Warranty .....	34
18-3	Production Discontinuance.....	34
18-4	Repair Condition.....	34
19.	Others.....	35

# 1. Introduction

Thank you for choosing DMC products.

Please read this manual carefully and use the product correctly.

# 2. Notes





- Reproduction and/or duplication of this product and/or this manual, in any form, in whole or in part, without permission is strictly prohibited.
- Contents of this product and/or this manual are subject to change without previous notice .
- Although all efforts have been made to ensure the accuracy of this product and/or the contents of this manual, should you notice any errors or have any questions, feel free to contact and notify us.
- DMC shall not be held liable in any way for damages or losses, nor be held responsible for any claims by a third party as a result of using this product.

# 3. Precautions for safe use

Precautions are noted in this manual in order for the product to be used safely. Read this manual along with other related manuals carefully to understand the correct handling and functions of the EMG7.

### Safety Symbol Legends

Safety symbols listed below are noted throughout this manual for the EMG7 to be used correctly and safely. These symbols stand for very important safety information as noted below:

 Warning	Indicates a procedure, condition, or statement that, if not strictly observed, could result in severe human injuries or loss of life.
 Caution	Indicates a procedure, condition, or statement that, if not strictly observed, could result in human injuries or property damage.
	Indicates a procedure, condition, or statement that is strictly prohibited for correct use of the equipment. (Forbidden)
	Indicates a procedure, condition, or statement that should be strictly followed for correct use of the equipment. (Mandatory)

### 3-1 Warnings



Warning!

#### Warnings for Design

- ⊘ Designing switches that can cause human injuries and/or property damages on the Touch Screen is strictly prohibited. Unintentional output signals due to malfunction of the main body, units, and/or cables can cause serious injuries. Design the system so that switches with major functions are equipped on devices other than the EMG7 itself.
- ⊘ Designing safety related switches on EMG7 is prohibited. Switches related to safety, such as emergency stop switches, should be made on a different hardware.
- ⊘ Design the system so there is no malfunctions due to communication anomalies between the host controller and the EMG7. It can cause human injuries and/or property damages.
- ⊘ Do not use EMG7 as a major warning device that may cause injuries/serious material damages, and or production stoppage. Control devices related to critical warning displays and warnings should be structured on an independent, redundant hardware system or a mechanical interlock.
- ⊘ EMG7 is not intended for use for aircraft equipment, aerospace instruments, trunk line communication equipment, nuclear power control equipment, and medical equipment that concerns life support, and or other equipment that concerns high reliability and safety. It cannot be used for these purposes.
- ❗ When using the EMG7 for purposes that concern high reliability and safety of functions and accuracy, such as transport equipment (trains, automobiles, ships, etc.), crime/disaster prevention devices, various safety devices, and medical equipment that does not concern life support, be sure to have safety features including redundancy and false operation prevention measures incorporated into the entire system.
- ⊘ Display will black out when the backlight goes out. If mistakenly operated in this condition, it might result in improper operation. Do not design touch-switches that might cause human injuries and material damages on the EMG7:  
Below symptoms will occur when the backlight goes out:  
1: Display goes out when "backlight off" function is not set.  
2: Display does not recover when display is touched after display goes out with "backlight off" function set.

#### Warnings for Handling

- ⊘ Do not modify/disassemble the EMG7. It may cause fire and/or electric shocks.
- ⊘ Do not use around flammable gas. It may cause explosions.
- ⊘ Do not put any kind of liquid, such as water, and metals in to the product. It may cause fires and/or electric shocks.

### Warnings for Wiring

- ❗ For wiring and installation, please refer to the manual and specification in order to conduct it correctly. It may cause fires and/or electric shocks.
- ❗ Before installing the power cable, make sure power is not being supplied from power source. It may cause electric shocks.
- ⊘ Do not use power voltage other than what is specified. It may cause fires and/or electric shocks.

### Warnings for Applying Current and Maintenance

- ⊘ Do not insert and remove communication cable while applying power.
- ❗ EMG7 uses lithium batteries for the clock and part of memory back-up. Batteries may need to be replaced after prolonged use. If replacement is necessary, please do refer to the instructions correctly.

## 3-2 Cautions



### Cautions for installation

- ❗ Make sure cables are securely connected to connectors to avoid wrong input and output due to loose connection.

### Cautions for Applying Current and Maintenance

- ⊘ During access to SD card, do not turn off the EMG7 or pull out the SD card. It might damage the data inside of the SD card.

### Cautions for Wiring

- ❗ Use D type grounding dedicated to EMG7 for FG terminals. It may cause electric shocks or malfunctions.
- ❗ Make sure chips and objects from wiring do not enter the EMG7. It may cause fire or malfunctions.

### Cautions for Disposal

- ❗ When disposing the product, please treat it as industrial waste.

## Precautions for Safe Use

- ⊘ Do not press down hard on the display area of EMG7 with hard objects. It may break the LCD panel and may cause injuries. Also, do not press down on the panel with sharp objects such as mechanical pencils or drivers. It may damage the displays.
- ⊘ Installing EMG7 in areas out of the range of the specification will cause failures.
- ⊘ Do not use in areas where temperature rises and dwells rapidly. It may cause failures.
- ⊘ Avoid areas where rapid temperature change could cause condensation. It may cause failures.
- ⊘ Do not put any kind of liquid, such as water, or any metal parts into EMG7. It may cause failures or electric shocks.
- ⊘ Do not use or keep EMG7 in locations with exposure to direct sunlight, high temperature, fine particles, humidity, and/or vibrations.
- ⊘ Do not use or keep in areas where gasified chemicals are exuded into the air, or where chemical contamination can occur.  
Acid, Alkali, other saline chemicals: Failures due to corrosion  
Organic solvents: Fire
- ⊘ If the surface of EMG7 gets dirty, wipe with a dry, soft cloth dampened with a neutral detergent then wrung dry.  
Do not use thinner or organic solvents.
- ⊘ LCD of display will deteriorate with ultraviolet rays. Do not use or keep in areas under strong ultraviolet rays.
- ❗ When stored in sub-ambient temperature, LCD of display might coagulate and cause damage to the panel.  
Also, when stored in over-ambient temperature, the LCD will turn into isotropic liquid and will not turn back to its original state. Please store in specified ambient temperature.
- ❗ After turning off the power of EMG7, leave for a while before turning the power back on. It might not function normally.
- ❗ Be sure to take back-up assuming the loss of data in the EMG7 in an event of an unexpected accident.

### 3-3 Handling of LCDs

- 1) The LCD display contains skin-irritating materials. If liquid materials flow out due to damage and comes in contact with skin, wash the area under running water for at least 15 minutes and consult a doctor.
- 2) The LCD display might have uneven brightness according to the contents being displayed. This is not a malfunction.
- 3) Minute spots (dark or bright) may occur in the LCD display elements. This is a basic characteristic of the LCD display and not a malfunction.
- 4) When LCD display is viewed outside the specified view angel, the color might seem different. This is a basic characteristic of the LCD display and not a malfunction.
- 5) When displaying a same image for a long period of time, it might cause an image lag. This is a basic characteristic of the LCD display and not a malfunction.

In order to avoid image lags, please follow the below procedures:

1. When leaving the same image displayed, use the" display off" function.
2. Change the image displayed periodically and do not display the same image for a long period of time.

### 3-4 Handling of Touch Screens

- 1) If elements that change ambient environments or electric fields (capacitors with large capacity, power units, and materials with high permittivity such as metals) are set close to the product, it might have impact to the coordinate detection. Make sure to keep a good distance from the above unstable elements as much as possible when designing.
- 2) Due to the characteristics of the touch screen, its functions might become unstable according to the environment it is installed. For correct operations, perform sensitivity sensor calibration when building into a device.  
Also if at any time the touch screen operation become unstable due to changes in environment or installation conditions, perform sensitivity sensor calibration.
- 3) The touch screen surface is made of glass. Glass is subject to break once scratched. Please handle with care and avoid glass from contacting other glass and hard objects.
- 4) Touch screen may not operate correctly when there is moisture on the surface.  
When moisture is detected on the touch screen surface, please wipe it dry before use.
- 5) When designing applications, consider the fact that area slightly outside the display might be read as a coordinate due to the characteristics of the touch screen when touched.



### **3-5 Handling of SD card**

- 1) Use a computer for important data and take backup to an outside media (hard disc, CD-R, etc.) regularly. We will not be held liable for any data lost or changed that is registered in the SD card.
- 2) Do not remove the SD card or turn the unit power off during write or read. It may cause the data inside the unit or the SD card to be lost or damaged (deleted).
- 3) Please keep the socket terminal of the memory cards and SD card clear of foreign objects.
- 4) Do not touch the terminals with fingers or metal objects. It may cause malfunctions.
- 5) When inserting the SD card, make sure it is inserted in the correct direction.
- 6) Do not apply undue force when inserting/removing.
- 7) Do not insert anything other than a SD card into the SD card socket. Also be careful of any foreign objects entering the socket.
- 8) Do not bend, break, or place under heavy objects.
- 9) Do not place in areas with sudden temperature change. Condensing will cause malfunctions.
- 10) Do not place in areas near corrosive chemicals or where corrosive gases evolve. It may cause malfunctions.
- 11) When cleaning, wipe with a dry soft cloth.
- 12) When carrying and storing, place the SD card memory card in its protection case

### **3-6 Handling of Batteries**

- 1) This product uses primary batteries. Recharging is prohibited
- 2) Insulate the terminals with tape when discarding.  
It may generate heat, explode, or ignite if in contact with other batteries or metal objects.  
Be sure to follow the instructions of the local government (restrictions of the district) when discarding.
- 3) Check the polarity and make sure it is connected in the correct direction
- 4) Do not store in areas with direct sunlight, high temperature and/or high humidity
- 5) Disassembling and modifying is prohibited.
- 6) Do not change the batteries with wet hands
- 7) Please do not use other than the supplied battery.
- 8) Installing the battery should only be performed by trained personnel.
- 9) If the EM is VESA mounted, detach from the VESA arm when replacing the battery. Refer to the section, Mounting on a VESA arm.
- 10) The battery should only be installed when the unit is powered off.
- 11) Do not use any metallic item to remove the battery (such as screwdrivers, knives, pliers, and so forth).
- 12) Be careful to not drop the battery or any associated screws into the unit.
- 13) Be careful of edges on internal sides of the enclosure and frame.

## 4. Items Included in Package

Below are included in the package. Please check before use.

- EMG7 Main Unit 1unit

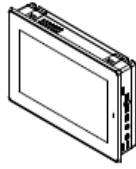

- Mounting Bracket (IS-TK-01) (4pcs/set)

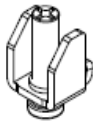

- Protection Sheet (1)



- Power Connector (1)

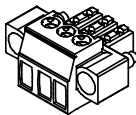

- Installation Guide (2) \*1

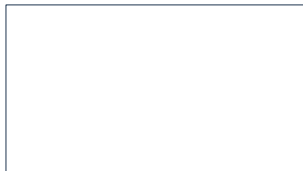

- Battery (1)



- Waterproof Gasket (1)

\*Already installed to unit

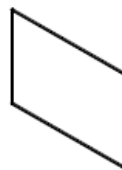

- Serial Connector (1)

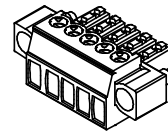

- Accessory List (2) \*1



\*1. 1 English version and 1 Japanese version.

<Note>

Although efforts have been made to ensure quality and packaging at shipment, should you notice any damage or a shortage of parts, please contact a dealer or DMC for additional instructions before use.

## 5. Names of Parts

### 5-1 Front

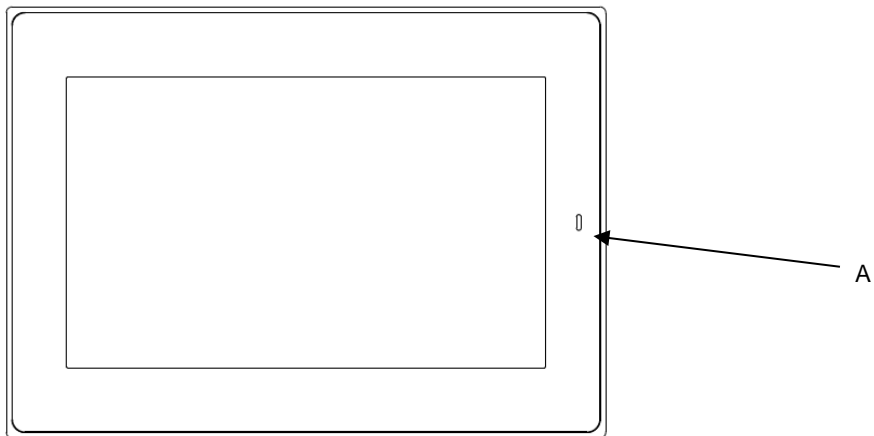

A) Status LED

The status LED displays the state of the EMG by the LED color shown below:

LED State	EMG State
Off	Power not applied
Amber, steady	OS starting
Green, steady	Normal operating state
Green, blinking	Backlight off (Normal Operation)

### 5-2 Back

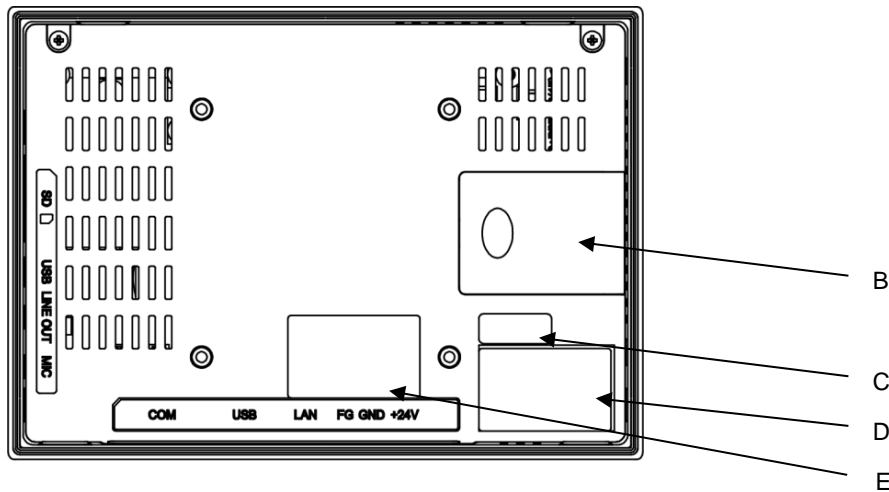

- B) Battery Cover
- C) License Seal (Windows Compact 7 Model only)
- D) Product label
- E) FCC label

### 5-3 Right

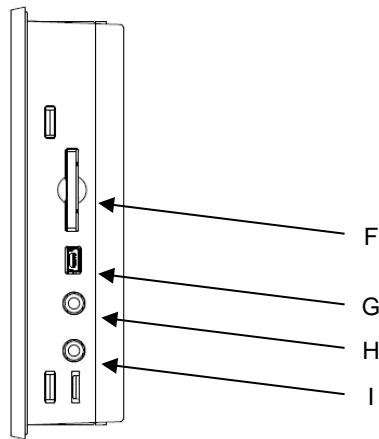

- F) SD Card Slot
- G) USB Device
- H) Audio Interface (LINE OUT)
- I) Audio Interface (MIC IN)

### 5-4 Top



- J) Mounting Holes

### 5-5 Bottom

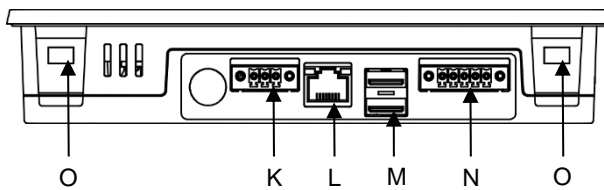

- K) Power Input
- L) Ethernet
- M) USB Host
- N) Serial Port (COM1)
- O) Mounting Holes

## 6. External Interface

### 6-1 SD Card Slot

Connector : SD / SDHC memory card (Push-in/push-out method)  
 Corresponding media : SD/SDHC memory card  
 Maximum capacity : 32GB

### 6-2 Serial Port (COM1)

Serial port : RS232C  
 Connector : Euro terminal connector (<Tyco Electronics> 284539-5)  
 Recommended cable connector : (<Tyco Electronics>284510-5) \*Included as accessory.

PIN No.	Signal	Schematic
1	TXD	
2	RXD	
3	RTS	
4	CTS	
5	SG	

### 6-3 Ethernet

Ethernet : 10BASE-T/100BASE-TX  
 Connector : RJ-45

PIN No.	Signal	Schematic
1	TX+	
2	TX-	
3	RX+	
4	NC*1	
5	NC*1	
6	RX-	
7	NC*1	
8	NC*1	

\*1. NC is 'not connected'.

#### Status LED

LED State	State
On, Green	LINK/ACT
On, Yellow	SPEED

Compatible cable : Above category 5

## 6-4 USB Host Port

Interface : USB2.0

Number of Ports : 2

Connector : Type-A

Maximum supply current: 0.5A / Port

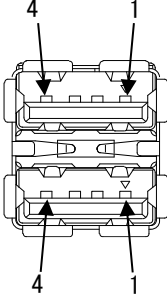
PIN No.	Signal (All ports common)	Schematic
1	USB_VCC	
2	D-	
3	D+	
4	SG	

## 6-5 USB Device Port

Interface : USB2.0

Connector : Type-B Mini connector

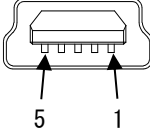
PIN No.	Signal	Schematic
1	USB_VCC	
2	D-	
3	D+	
4	NC <sup>※1</sup>	
5	SG	

※1 NC is "Not Connected"

## 6-6 Audio Interface (LINE OUT)

Interface : LINE OUT (Stereo)

Connector :  $\phi$ 3.5 Stereo JACK

Maximum output level : 1Vrms

Use built-in amplifier when connecting to speakers.

PIN No.	Signal	Schematic
1	SG	
2	Lineout R	
3	Lineout L	

## 6-7 Audio Interface (MIC IN)

Interface : MIC IN (Mono)

Connector :  $\phi$ 3.5 Stereo JACK

Maximum input level : 250mVrms

PIN No.	Signal	Schematic
1	SG	
2	NC*1	
3	MIC	

※1 NC is "Not Connected".

## 6-8 Power Connector

Interface : 24VDC IN

Connector : Euro terminal connector (<Tyco Electronics>284539-3)

Recommended cable connector : (<Tyco Electronics>284510-3) \*Included as accessory.

PIN No.	Signal	Schematic
1	FG	
2	GND	
3	+24VDC	

## 7. Specification

### 7-1 General Specification

Item		Specification
Power	Voltage Rating	24VDC
	Voltage Allowance Range	24VDC±20%
	Power Consumption※1	15W or under (Typ. 7W)
	FG Connection	FG (Frame GND) and SG (Signal GND) are connected internally. FG (Frame GND) and GND are not connected.

※1 Power consumption for EMG7 unit only. Consider the power consumption of USB devices when connecting the USB.

### 7-2 Environmental Specification

Item	Specification
Ambient Operating Temperature (inside of panel and display surface)	0°C to 55°C
Ambient Storage Temperature	-10°C to +60°C
Ambient Operating Humidity	10%RH to 85%RH (non-condensing. Wet-bulb temperature is 39 °C or less)
Ambient Storing temperature	10%RH to 85%RH (non-condensing. Wet-bulb temperature is 39 °C or less)
Dust	Prohibited
Corrosive Gas	Corrosive gas Prohibited
Environment	Pollution Degree 2, Indoor use
Pressure Resistance (Frequency of Use)	800hPa to 1114hPa (Altitude up to 2000m)
Vibration Resistance	IEC61131-2(JIS B 3502) compliant 5Hz to 9Hz Single amplitude 3.5mm 9Hz to 150Hz Fixed acceleration 9.8m/s <sup>2</sup> X,Y,Z directions for 10times(100min.)



### 7-3 Installation Specification

Item	Specification
Grounding	Grounding resistance of 100Ω, 2mm <sup>2</sup> [0.0062inch <sup>2</sup> ] or thicker wire, or your country's applicable standard.
Structure	Protection Structure: IP65 *1 (Front side only when mounted to panel) Installation : Panel mounting
Cooling Method	Natural Convection
Weight	App. 700g
Exterior Measurement	192(W) x 137(H) x 36(D) mm
Panel Cut	183.5 <sup>+0.5/-0</sup> (W) x 128.5 <sup>+0.5/-0</sup> (H) mm
Color	Black

※1 Protection structure of front surface when installed in a panel. It has been tested to verify compliance but does not guarantee for all environmental use. Especially for oils defined in the test, in cases where prolonged exposure to vaporized oils or cutting fluids with especially low viscosity, oil might enter to front area through area where touch screen has lifted and may need special measurements. Please check the installation environment prior to the use of EMG7.

Also, gaskets that have been used for a long time, or gaskets that have once been applied to panels, the original level of the protection cannot be guaranteed. To maintain the original protection level, be sure to replace the gasket regularly.

## 8. Installation

### 8-1 Installation Conditions

- When mounting to panel, be sure to have enough room to insert and remove the SD card, cables, and mounting brackets.
- Consider specification temperature between EMG7 and the structure and parts. Be sure to have good ventilation.
- Please use in ambient temperature of 0 to 55°C and ambient humidity of 10 to 85%RH(Wet bulb temperature is 39°C or less)
- Ambient operation temperature indicates the temperature inside the cabinet where it is installed as well as the panel surface.

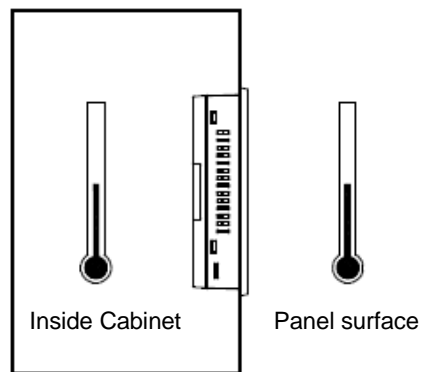

- EMG7 should not be mounted at an angle more than 30° from vertical state as illustrated in the following figure.

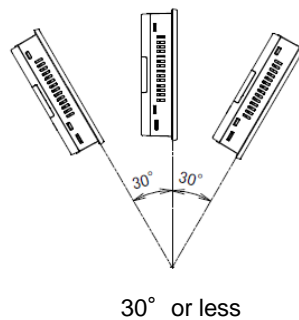

- When installing the EMG7 in a slanted panel of angle 30 degrees or more, please use forced air cooling to ensure the temperature specification

## 8-2 Panel Mounting

### 8-2-1 Panel Dimension

Panel thickness range: 1.0 mm to 5.0 mm

Panel opening size : 183.5×128.5mm

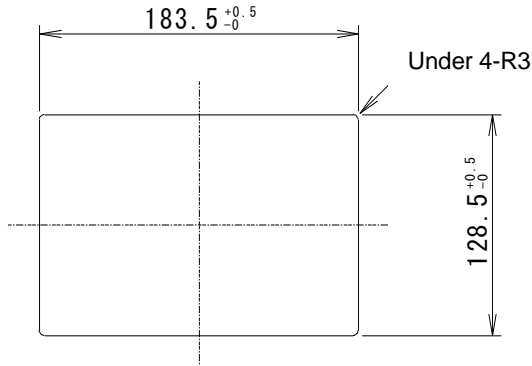

- Material of the mounting panel should be made of metal.
- Even within the recommended panel thickness range, depending on the material and size, the strength may not be maintained when pressure is applied. In environments where shocks will be applied, please consider more reinforcement.
- Please be careful not to drop, as there is a possibility of injury or product damage when dropping the product.

### 8-2-2 Installing the Gasket

Please install the gasket even in environments where it may not seem necessary.

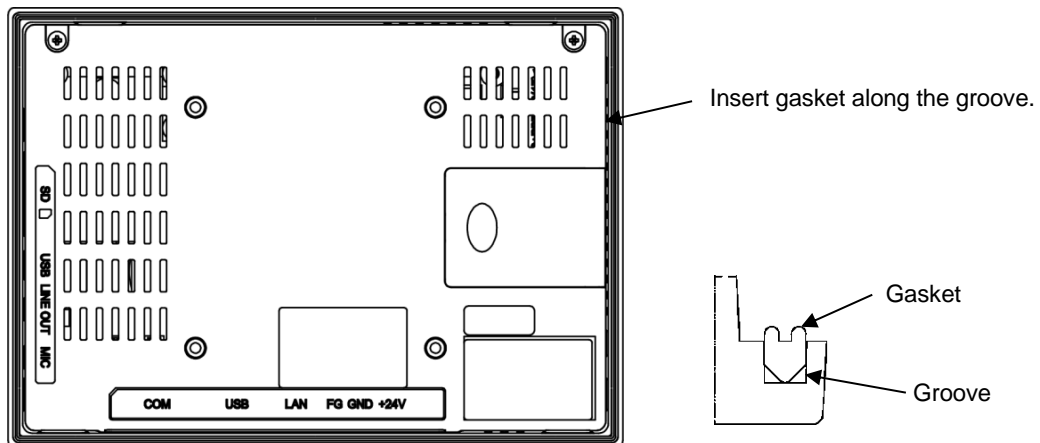

- ※Gasket will be installed to the unit before shipment.
- Please make sure it is properly installed before use.

### 8-2-3 Installation Procedure

- ① Install unit (with gasket installed) to the panel from the front.

\*Make sure it is installed in the correct direction

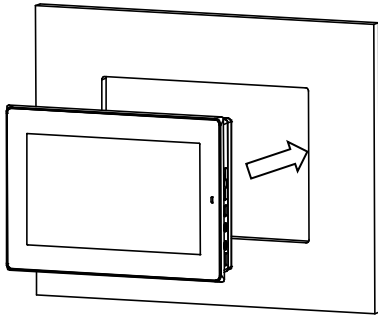

- ② Insert mounting hook in the mounting holes in the four locations of the unit.

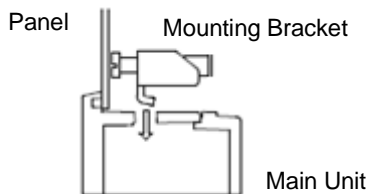
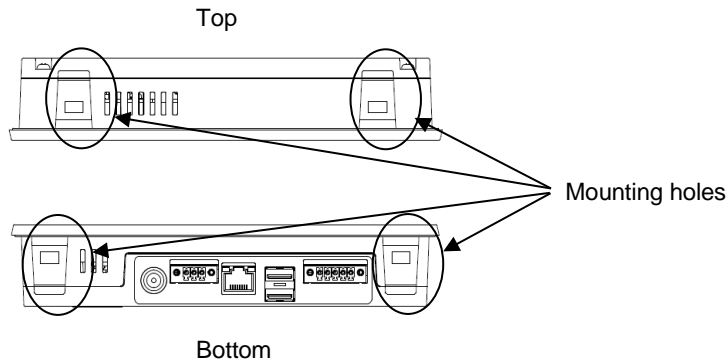

- ③ Tighten screw of mounting bracket and slide the bracket.

Tighten the screws a little at a time in all four locations working diagonally.

Appropriate torque for tightening is  $0.3\text{N}\cdot\text{m}$ .

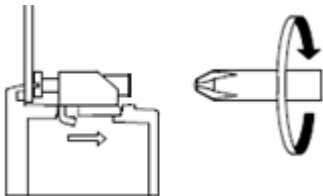

#### Note

- If the screw of the mounting bracket is not perpendicular to the panel, the unit might fall off the panel .
- If screw is too tight, the unit might deform or damage. Please tighten with appropriate torque

### 8-3 Mounting to a “VESA” Arm

EM can be installed on a commercially available Video Electronics Standards Association (VESA) MIS-D arm, stand, or apparatus that is listed to comply with the UL1678 standard.

Refer to manual of arm or stand for installation procedures.

Mounting hole dimension is as below

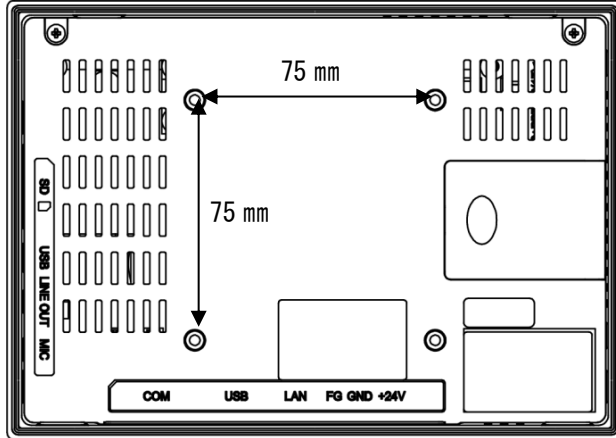

Use M4 screws to mount.

The tightening torque range is 0.7 to 0.8Nm.

M4 screws used should be 6mm or less in length

#### VESA Standard Arm

VESA is an abbreviation for “Video Electronics Standards Association”, an industry group that establishes standards concerning displays for computers.

VESA establishes SVGA standards and VL Bus standards, and standardized below 2 types for the installation of LCD monitors.

- 75mm×75mm pitch
- 100mm×100mm pitch

EMG7 complies with the VESA standard for75mm.

## 9. Wiring

Make sure power is not supplied when connecting to avoid the risk of human injury or damage to equipment due to electrocution.

Do not turn the power on until all connections have been made.

When connecting each interface, review each interface specifications.

Prepare the cables to be used according to the specifications.

### 9-1 Using Accessory Connectors

Accessories of this product include Euro terminal connector for power and serial interface.

Connect the power, serial interface cable using the attached accessory cable.

#### ■ Connector Specification

① Power Connector : (284510-3 by Tyco Electronics)

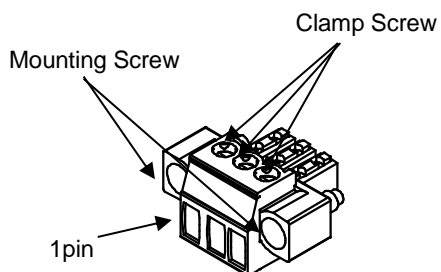

② Serial Connector : (284510-5 by Tyco Electronics)

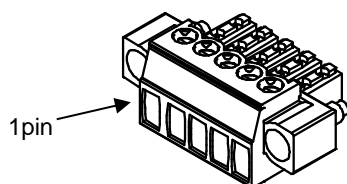

Clamp Screw Size : M2

Mounting Screw Size : M2.5

Torque : 0.3N·m

#### ■ Compliant Wire

Wire type	Single wire, Stranded wire
Conductor size	AWG14-30
Rating temp	75°C or more
Wire Stripping Length	<p>The diagram shows a wire with a section of its insulation removed. A vertical line indicates the length of the stripped section, which is labeled '5-6 mm'.</p>

When using stranded wire, the twisting of the core wire must be appropriate in order to avoid fine wires of the core wire from short circuiting with each other or electrodes nearby.

#### ■Wiring Procedures

Wire the power cables as instructed below.

- (1) Make sure power is not conducting.
- (2) Loosen the screw clamp on the connector.
- (3) Strip the cable; twist the core wire and insert to connection.
- (4) Tighten the screw clamp and fix the wire.
- (5) Connect the connector to interface of unit.
- (6) Tighten mounting screw and fix to unit.

### 9-2 Cautions for Power Supply Wiring

- (1) Wire the power source, input/output device, and power device of the EMG7 isolating each by sequence.
- (2) Do not bundle main circuit (High voltage, high current) wires, signal wires, and power cables, nor put them close to each other.
- (3) Twist the power cable as short as possible to improve noise immunity.
- (4) If there are any noise effects, attach a ferrite core to the power cable.
- (5) A Safety Extra Low Voltage (SELV) and Limited Energy Circuit or SELV and Class 2 dc power supply.
- (6) The user calculates proper gauge wiring for current carrying capacity and loss according to local regulations.
- (7) Connect a lightning surge absorber for lightning surge measures.
- (8) Separate lightning surge absorber connection (E1) and grounding of EMG7 (E2).
- (9) Choose the lightning surge absorber so the power voltage maximum increase does not exceed the maximum capacity voltage circuit of the lightning surge absorber.

### 9-3 Cautions for Grounding

- (1) Have a dedicated grounding for power source cable FG. "Grounding construction is type D grounding, grounding resistance is 100Ω or lower."
- (2) SG (Signal ground) and FG (Frame ground) is connected inside of EMG7. When connecting connection apparatus and SG, design the system so there is no short circuiting loop.
- (3) Use a grounding wire of 2mm<sup>2</sup> or more. Shorten the grounding wire distance near the grounding point of EMG7. If the grounding wire is long, than use a large insulation wire when setting.

### 9-4 Caution for Wiring of Signal Lines

- (1) Wire the signal wires in a different wiring sequence than the power cables and power circuits.
- (2) If the power circuit cable cannot be wired in a different sequence, use a shield cable and ground the shield terminal.
- (3) If there are any noise effects, attach a ferrite core to the signal wire

## 10. Inserting and Removing the SD Memory Card

### 10-1 Inserting the Memory Card

(1) Insert the Memory card in the SD card slot on the right side of the unit.

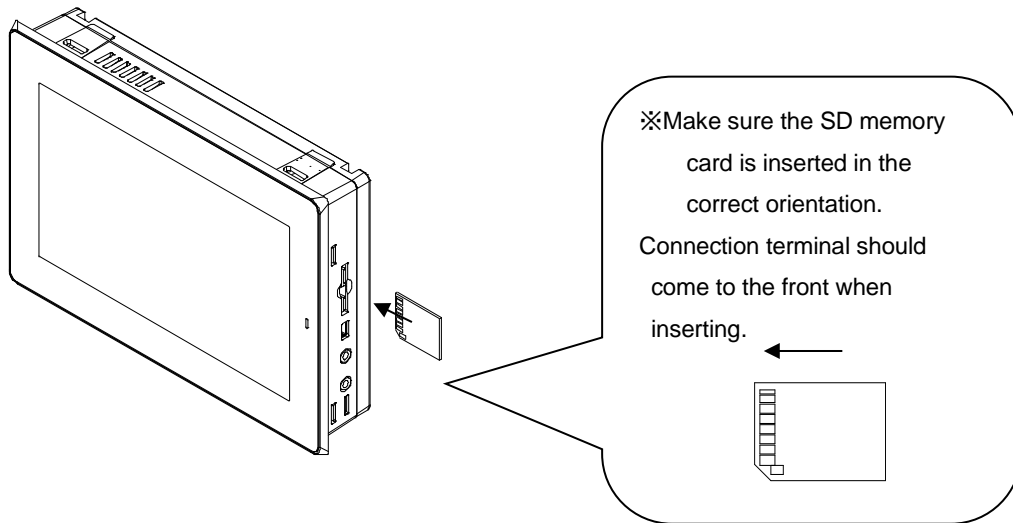

(2) Push in SD memory card with fingers until it locks.

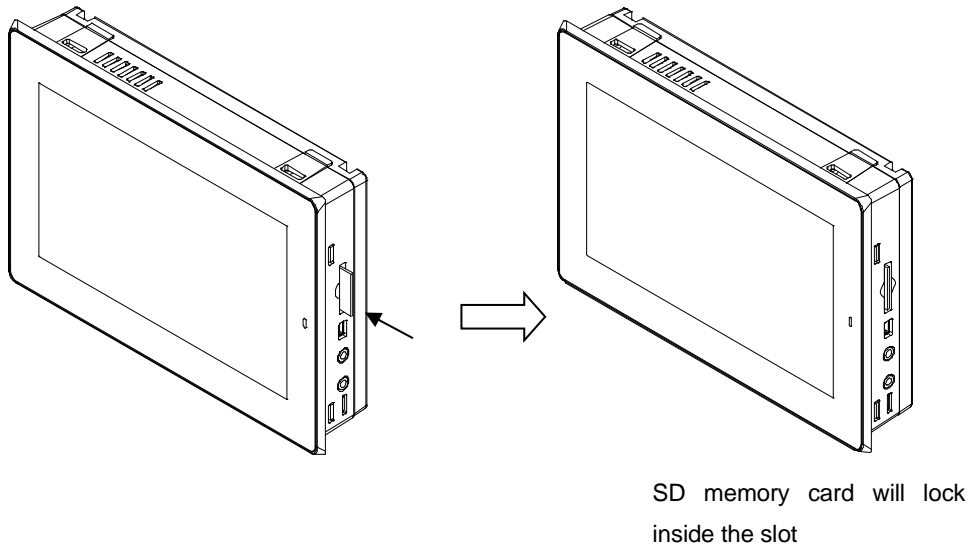



## 10-2 Removing the SD Memory Card

(1) SD memory card will slightly pop out when pushed further into the slot.

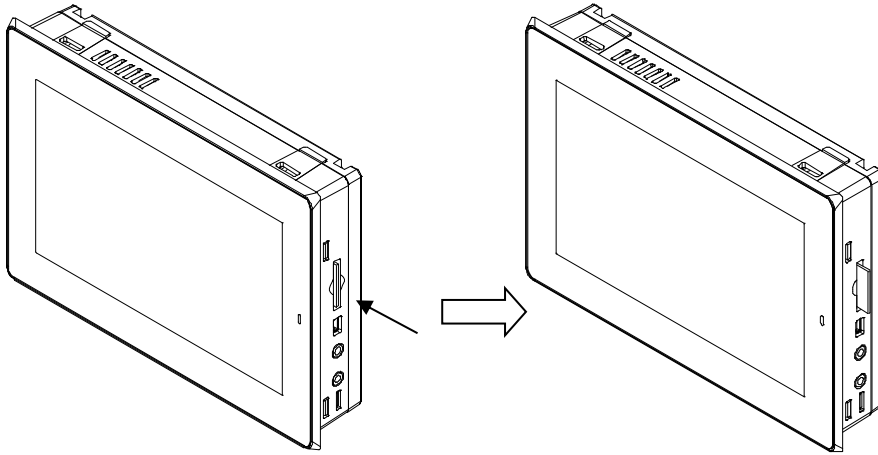

(2) Pinch and pull out the SD memory card.

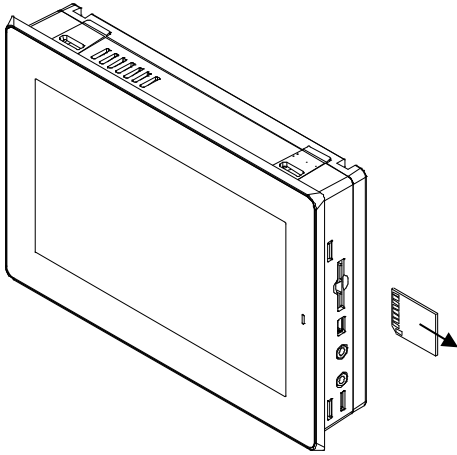

### Note:

- Be sure to insert the SD memory card in the correct direction and do not insert in the wrong direction.
- Be sure to take back-up data of the SD memory assuming unexpected accidents.
- Do not attempt to forcibly pull out the SD memory card.
- Do not attempt to pull out the SD memory card when in access.

## 11. Connecting and Changing of Batteries

SRAM, RTC can be backed up by connecting the battery.

Batteries are not connected at purchase. If you need back-up, please connect the attached battery

### 11-1 Battery Connecting and Changing Procedure

(1) Remove the battery cover by pushing down on the concave area and sliding outward.

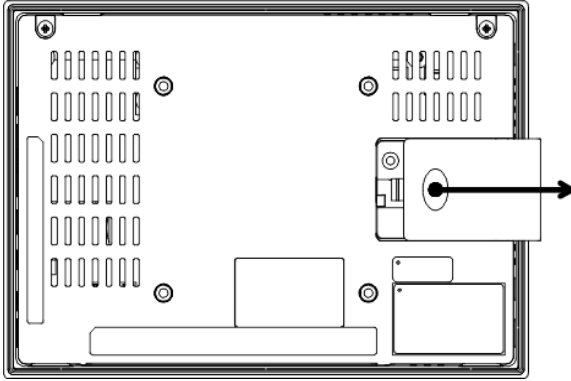

(2) Connect the harness of the battery as shown in the diagram.

When changing batteries, pull out the old battery, and disconnect the connector before exchanging to new batteries.

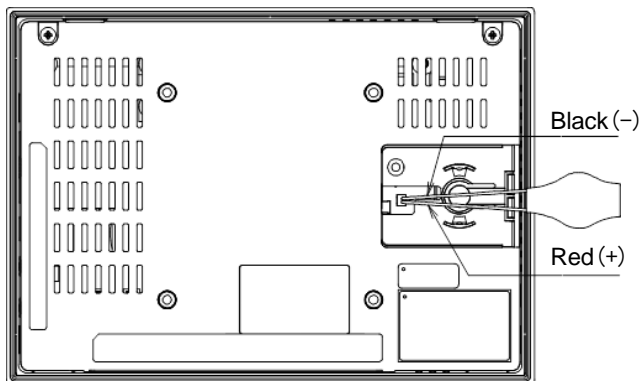

\*Check the polarities and make sure it is not inserted in the wrong direction.

(3) Insert the battery as shown in the below diagram.

Be sure the harness does not come above the protruding tab.

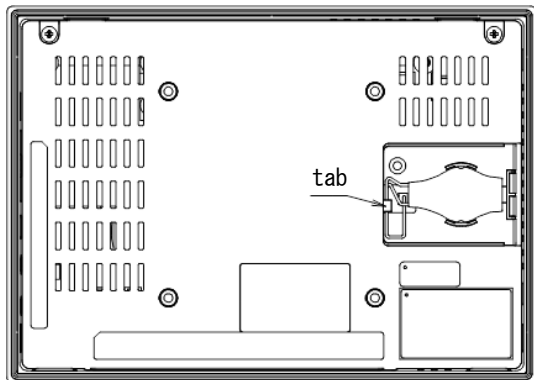

(4) Make sure the harness does not get caught when putting the battery cover back on.

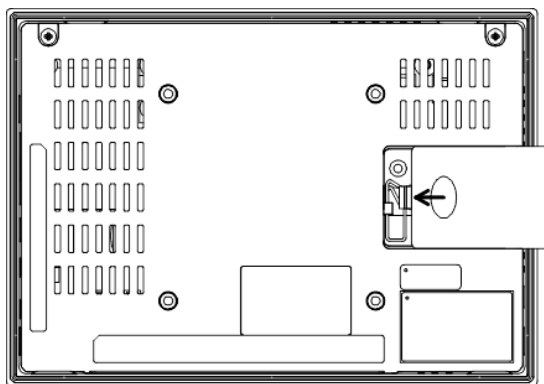

**Note:**

- Please be careful of how the used batteries are handled.
- We will not be held liable for any data lost at battery exchange  
Please be sure to take SRAM data backup.
- Replace the battery with DMC part number SWBT-01.

## 12. Applying Protection Sheet

### 12-1 Application Procedure

Apply the protection sheet accordingly to the exterior shape of the glass on the side to be applied.

- (1) Wipe any dust and fingerprints off the display side (side to be applied).
- (2) Peel part of the transparent back paper (about 2cm) off the protection sheet so adhesive area is visible.
- (3) Apply adhesive area on the display side (side to be applied)
- (4) Apply the whole protection sheet by peeling off the back paper little by little.
- (5) Peel off the curing film (green) on the surface of the protection sheet.

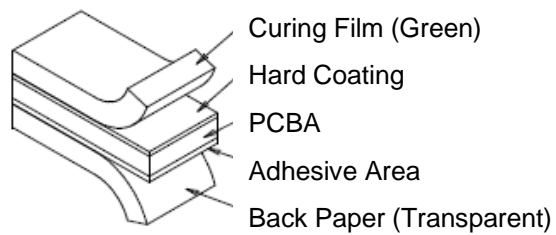
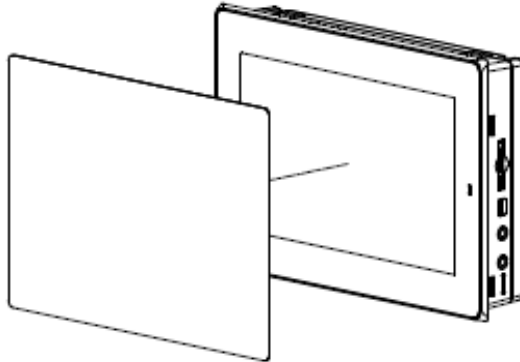

※Use scotch tape when back paper of curing film is difficult to peel off.

#### Note

- Do not paste with water on the display side.
- For indoor use.

## 13. Calibration

There are two types of calibration to EMG7. One type is sensor sensitivity calibration to optimize the touch screen function by resetting the influence of ambient noise or metals of the installation environment, and the other is to set the value of coordinate with the pressed point.

### 13-1 Sensor Sensitivity Calibration

Calibrate after building in or when the touch screen function becomes unstable due to the ambient environment or its installation condition.

It is recommended that the sensor sensitivity calibration be performed in the same environment and condition that it will be used in.

Sensor sensitivity calibration can be done by set-up tool or by a switch.

See the following setup-tool manual for further detail.

Model	Document
EMG7-W207A8-0024-x11-01	Setup tool manual (12A4A5-00044)
EMG7-W207A8-0024-107-01	Tool manual (17A4A5-00017)

#### 13-1-1 Sensor Sensitivity Calibration Procedure (by switch)

- (1) Slide and remove battery cover by pressing down on the concave area.

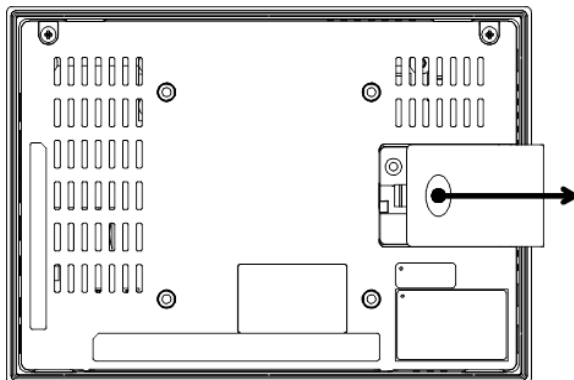

- (2) Press the switch and calibration will run.

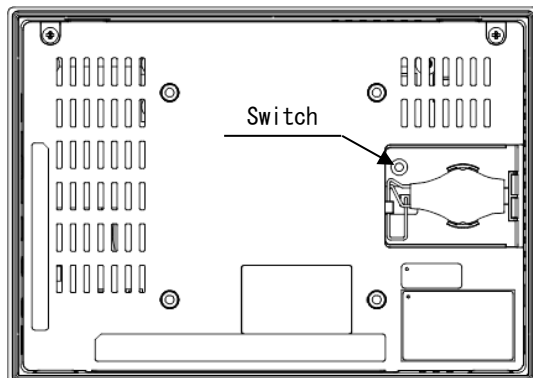

(3) Once calibration starts, below window will appear.

Do not touch the product until calibration ends normally.

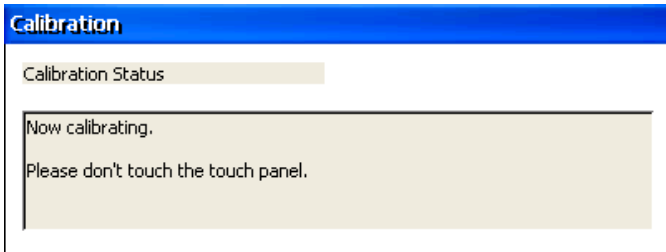

After a while calibration will end automatically.

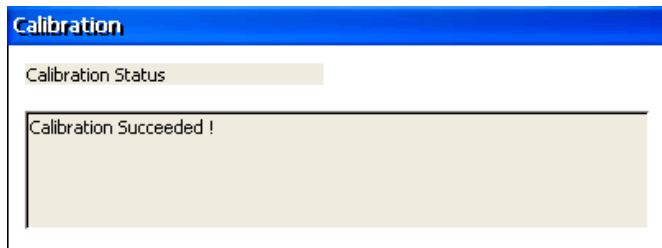

(4) After calibration ends, reboot and make sure the touch screen can be operated correctly.

If it does not operate normally, go through the calibration process again.

(5) Make sure the harness does not get caught when putting the battery cover back on.

### 13-2 Coordinate Calibration

Calibrate if there is a big misalignment of the pressed point and the detected coordinate. Coordination Calibration can be performed from the set-up tools.

See the following setup-tool manual for further detail.

Model	Document
EMG7-W207A8-0024-x11-01	Setup tool manual (12A4A5-00044)
EMG7-W207A8-0024-107-01	Tool manual (17A4A5-00017)

## 14. Starting Method

Make sure power wiring is complete before turning on the power.

Status LED will light up (orange).

Momentarily the status LED will become Green and OS will boot up.

## 15. Maintenance

### 15-1 Display

When surface of display or frame gets dirty, wipe with a soft cloth damped in diluted neutral detergent and wrung dry.

 Do not use thinner, organic solvent, or strong acidic solvents.

### 15-2 Regular Maintenance

To keep the EMG7 in best shape, please conduct maintenance on a regular basis.

#### Surrounding Environment Check

(1) Ambient temperature is within specification range (0 to 55°C)

(2) Ambient humidity is within specification range (10 to 85%RH)

(3) Ambient pressure is within specification range (800 to 1114hpa)

#### Electronic Specification Check

(1) Voltage is within permissible range(24VDC±20%)

#### Installation Check

(1) Make sure the connection cables are inserted firmly and completely.

(2) Mounting brackets are installed firmly without any looseness.

### 15-3 Changing of Batteries

EMG7 has built in battery for back up of SRAM and clock data.

If back-up battery needs to be exchanged, please return it to DMC or follow the instructions specified in this manual.

## 16. Compatible Standards

EMG is intended for use in industrial environments and, when properly installed, shall comply with the following agency approvals.

### 16-1 UL Standards

This product is UL standard compliant

UL standard No.	UL Registration Model No.	UL File No.
UL 61010-1; UL 61010-2-201; CSA C22.2 No 142-M1987;	G-0001UA	E464360

### 16-2 CE Marking

This product is EMC Directive of EU compliant

Complying standard : EMI:EN 61000-6-4:2007+AI:2011  
EMS:EN 61000-6-2:2005

### 16-3 RoHS Directive

This product is RoHS Directive of EU compliant.

### 16-4 FCC

The FCC requires the following note to be published according to FCC guidelines:

Note:

This equipment has been tested and found to comply with the limits for a Class A digital device, pursuant to Part 15 of the FCC Rules. These limits are designed to provide reasonable protection against harmful interference when the equipment is operated in a commercial environment. This equipment generates, uses, and can radiate radio frequency energy and, if not installed and used in accordance with the instruction manual, may cause harmful interference to radio communications. Operation of this equipment in a residential area is likely to cause harmful interference in which case the user is required to correct the interference at their own expense. Changes or modifications to this unit that are not expressly approved by DMC could void the user's authority to operate the equipment.

Industry Canada requires the following note to be published:

Note:

This Class A digital apparatus complies with Canadian CAN ICES-3 (A)/NMB-3 (A).



## 17. List of Option

### ■ Mounting brackets

Model	Description
IS-TK-01	4pcs

### ■ Development kit

Model	Description
SWDK-101	Power supply unit Software development environment(DVD)

\*The option for EMG7-W207A8-0024-107-01 (Linux Model)

This is needed when using InfoSOSA application.

## 18. Warranty and Repair

### 18-1 Inquires

In case of defects or when repair is needed for DMC products, feel free to contact us.

In case of making inquiries, please confirm the issue or the symptom beforehand. Also, when sending the product, please include a fully filled "Repair Request" form with the issue or the symptom noted.

Please make sure the product is packaged so it will not get damaged during shipment.

### 18-2 Warranty

The warranty period is limited to one year from the date of shipment. Any defects that occurred under proper use and environment noted in the specification will be repaired without charge (On-site repair). (The warranty for defects of the same area is three months.)

You will be liable for all repair fees even within the warranty period for any conditions listed below.

- (1) Any malfunctions and damages during transportation and transfer of mishandling by user after delivery.
- (2) Any malfunctions and damages caused by natural or man-made disaster
- (3) If the product is used under any condition, in any environment, or by any method other than those described in the product specification, catalogs, manuals or others.
- (4) Replacement of consumables
- (5) Any malfunctions and damages caused by failure of associated equipment, inappropriate consumables, and media.
- (6) Any malfunctions caused by science or technology that could not be predicted at time of sales.
- (7) Other malfunctions, damages, and/or defects that is considered to be caused by the user

The warranty only covers the product itself. Repair and replacement of damages caused by the failure of the product and/or repair and replacement will be charged.

### 18-3 Production Discontinuance

In the event of product discontinuance, an announcement will be made on our website at least six months prior to the discontinuance.

### 18-4 Repair Condition

- (1) Only DMC products can be repaired. Options are exempt.
- (2) Programs and data might be lost during repair. Please be sure to take back-up. DMC will not be held liable for any programs or data lost during repair.
- (3) All user information recorded in our product will be handled with much care. However, we ask that any important security information be deleted before repair.
- (4) Repairs will be done in our workshop after it is sent back. All shipping fee will be charged.
- (5) DMC will have all ownership for parts exchanged at repair.

## 19. Others

If you have comments or questions, please feel free to contact us.

North South America area

✉ [technical-global@dush.co.jp](mailto:technical-global@dush.co.jp)

Asia Pacific area

✉ [technical-global-asia@dush.co.jp](mailto:technical-global-asia@dush.co.jp)

Europe, Middle East, Africa area

✉ [technical-global-eu@dush.co.jp](mailto:technical-global-eu@dush.co.jp)

FAQ

 [www.dush.co.jp/english/support/faq/](http://www.dush.co.jp/english/support/faq/)

Microsoft® , Windows® Embedded Compact7 is a registered trademark of Microsoft Corporation of the United States and other countries.

---

7<sup>th</sup> Edition October 2023

DMC Co., Ltd.

Office hours: 9:00 - 17:00 weekdays

(except Saturdays, Sundays, national holidays, and year-end and New Year holidays)

URL: <https://www.dush.co.jp/english/>

This product and document are protected by the copyright law.

Photocopying, duplicating, reproducing, and modifying of this product or document in part or by whole is prohibited.

Copyright(C) 2023 DMC Co., Ltd. All Rights Reserved