



InfoSOSA™ Series
4.3" Touchscreen Display

IS731-4

Model: IS731-4WQ1-D05

Instruction Manual

Table of Contents

1. Introduction	3
2. Notes.....	3
3. Precautions for Safe Use	3
3-1 Warnings.....	4
3-2 Cautions	5
3-3 Handling of LCD Panels	6
3-4 Handling of Batteries	6
3-5 Handling of Image Files	6
4. IS731 Series Products	7
4-1 General Specification.....	7
5. Packaged Contents.....	7
5-1 Standard Specification.....	7
6. Part Names and Their Functions.....	8
6-1 Main Unit	8
7. Installation and Wiring.....	9
7-1 Installation	9
7-2 Installation	9
7-2-1 Panel Opening Example.....	9
7-2-2 Panel Mounting Procedures	10
7-3 Wiring Procedure.....	11
7-3-1 Wiring Location.....	11
7-3-2 Connecting Unit to Power.....	12
7-3-3 Connecting to USB Mini-B Cable	12
7-3-4 Connecting to Communication Cable	13
7-3-5 Connecting to Battery	14
7-3-6 Connecting Design Sheet Key Tail	15
7-4 Mounting Conditions.....	16
8. Starting the InfoSOSA.....	17
9. Starting the Development Tool (InfoSOSA Builder).....	17
10. Maintenance.....	18
10-1 Display Maintenance	18
10-2 Regular Inspections	18
11. Warranty and Repairs	19
11-1 Repairs	19
11-2 Warranty	19
11-3 Production Discontinuance	20
11-4 Repair Warranty.....	20
12. Others	21

1. Introduction

Thank you for choosing DMC products. Please read this manual carefully and use our product correctly. This document describes the manual of the InfoSOSA™ Series 4.3" touchscreen display.

2. Notes





- Reproduction and/or duplication of this product and/or this manual, in any form, in whole or in part, without permission is strictly prohibited.
- Contents of this product and/or this manual are subject to change without previous notice.
- Although all efforts have been made to ensure the accuracy of this product and/or the contents of this manual, should you notice any errors or have any questions, feel free to contact and notify us.
- DMC shall not be held liable in any way for damages or losses, nor be held responsible for any claims by a third party as a result of using this product.

3. Precautions for Safe Use

Precautions are noted in this manual in order for the product to be used safely. Read this manual along with other related manuals carefully to understand the correct handling and functions of the InfoSOSA.

Safety Symbol Legends

Safety symbols listed below are noted throughout this manual for the TM to be used correctly. These symbols stand for very important safety information as noted below:

 Warning	Indicates a procedure, condition, or statement that, if not strictly observed, could result in severe human injuries or loss of life.
 Caution	Indicates a procedure, condition, or statement that, if not strictly observed, could result in human injuries or property damage.
	Indicates a procedure, condition, or statement that is strictly prohibited for correct use of the equipment. (Forbidden)
	Indicates a procedure, condition, or statement that must be strictly followed for correct use of the equipment. (Mandatory)

3-1 Warnings



Warnings for Design

- ⊘ Designing switches that might cause human injuries and/or property damage on the touch screen is strictly prohibited. Unintentional output signals due to malfunction of the main body, units, and/or cables, etc. can cause serious injuries. Design the system so that switches with major functions are equipped on other devices.
- ⊘ Designing safety related switches on the InfoSOSA is prohibited. Switches related to safety, such as emergency stop switches, should be made on a different hardware.
- ⊘ Design the system so the device will not malfunction due to communication abnormalities between the IS and the host controller. Failure to follow may result in injury to the human body or damage to properties.
- ⊘ Do not use InfoSOSA as a major warning system that may cause injuries/ serious material damages, and or production stoppage. Control devices related to critical warning displays and warnings should be structured on an independent, redundant hardware system or a mechanical interlock.
- ⊘ InfoSOSA is not intended for use for aircraft equipment, aerospace instruments, trunk line communication equipment, nuclear power control equipment, and medical equipment that concerns life support, and or other equipment that concerns high reliability and safety. It cannot be used for these purposes.
- ❗ When using the InfoSOSA for purposes that concern high reliability and safety functions and accuracy such as transport equipment (trains, automobiles, ship, etc.), crime/disaster prevention devices, various safety devices, and medical equipment that does not concern life support, be sure to have safety features including redundancy and false operation prevention measures incorporated into the entire system.
- ⊘ Display will black out when the backlight goes out. If mistakenly operated in this condition, it might result in improper operation. Do not design touch-switches that might cause human injuries and material damages on the InfoSOSA.
Phenomenon as below will occur when the backlights go out:
 - (1) Screen will go out even if the Backlight OFF function is not set.
 - (2) Display does not recover at touch after the backlight goes off as well as the display.

Warnings for Handling

- ⊘ Do not modify/disassemble the TM. It may cause fires and/or electric shocks
- ⊘ Do not use around flammable gas. It may cause explosions.
- ⊘ Do not put any kind of liquid, such as water, and metals into the product. It may cause fire and/or electrical shocks.

Warnings for Wiring

- ❗ For wiring and installation, please refer to the manual and specifications in order to conduct it correctly. It may cause fires and/or electric shocks.
- ❗ Before installing the power cable, make sure power is not being supplied from power source. It may cause electrical shock.
- ⊘ Do not use power voltage other than what is specified. It may cause fires and/or electric shocks.

3-2 Cautions

Cautions

Cautions for Disposal

- ❗ When disposing the product, please treat it as industrial waste.

Precautions for Safe Use

- (1) Do not press down on display with strong power or hard objects. It may break the LCD panel and cause injuries.
- (2) Please use this product within the specified ambient temperature and humidity range. If not used properly, it may cause malfunctions.
- (3) Do not press down on the display area of InfoSOSA with sharp objects such as mechanical pencils or drivers. It may damage the display.
- (4) If the surface of InfoSOSA gets dirty, wipe with a dry, soft cloth damped with a neutral detergent then wrung dry. Do not use thinner or organic solvents.
- (5) Do not use in areas where rapid temperature change can cause condensation. It may cause malfunctions.
- (6) In order to prevent product temperature from rising, do not use in areas where heat can be trapped. Also prevent storing in areas of high temperature.
- (7) Do not use or store InfoSOSA in locations exposed to direct sunlight, fine particles, oil smoke and steam.
- (8) Do not use or store all precision equipment where shock or vibration can be applied.
- (9) Do not use or store in areas where gasified chemicals are diverged into the air, or where chemical contamination can occur.
- (10) Be sure to take backups of the data in case of an unintended accident.
- (11) When using power source with slow rise-time and fall-time, it may not operate correctly. Be sure to drop the voltage to 0V when turning the power back on after once turning off the power, before turning on the power. It may not boot correctly.
- (12) Please be warned that applications that require for one point to be pressed for a prolonged time may cause failures due to the touch screen's structural characteristics.
- (13) Touch screen coordinates may shift due to aging or depending on its operating environment. Conduct calibration of the touchscreen to correctly set the coordinates.

3-3 Handling of LCD Panels

- (1) The LCD display contains skin-irritating materials. If liquid materials flow out due to damage and comes in contact with skin, wash the area under running water for at least 15 minutes. If it gets into the eyes, wash under running water and consult a doctor.
- (2) The LCD display might have uneven brightness according to the contents being displayed. This is not a malfunction.
- (3) Minute spots (dark or bright) may occur in the LCD display elements. This is a basic characteristic of the LCD display and not a malfunction.
- (4) When LCD display is viewed outside the specified view angel, the color might seem different. This is a basic characteristic of the LCD display and not a malfunction.
- (5) When displaying a same image for a long period of time, it might cause an image lag. This is a basic characteristic of the LCD display and not a malfunction.

In order to avoid image lags, change the image displayed periodically and do not display the same image for a long period of time.

3-4 Handling of Batteries

- (1) Do not recharge the batteries.
- (2) When disposing, tape the terminal and make sure it is insulated. If not insulated, it may cause heat, explosions or ignite.
- (3) Confirm the +/- polarity and make sure the it is connected in the correct direction.
- (4) Do not store in areas exposed to direct sunlight, with high temperature and/or high humidity.

3-5 Handling of Image Files

When using image files, please use ones that were created by individual users.

Using and distributing, without permission, files protected by copyright is strictly prohibited by law.

Please note some free materials might have using restrictions.

4. IS731 Series Products

4-1 General Specification

Model	Specification Distinction*			
	Display size	Resolution	Rated voltage	Maximum support language
IS731-4WQ1-D05	4.3"	WQVGA (480×272)	5VDC	1 language*1

*1 language (Maximum of 1 system font language can be used.)

5. Packaged Contents

Below items are included in the package. Please make sure there no missing items before use.

Although all efforts have been made to assure the quality and packaging before shipment, if you notice any damages or missing items, please notify us before use.

5-1 Standard Specification

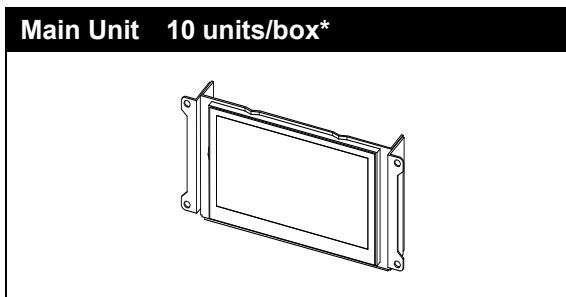

*Maximum number of units that could be stored: 10 units

6. Part Names and Their Functions

6-1 Main Unit

■ Front Side

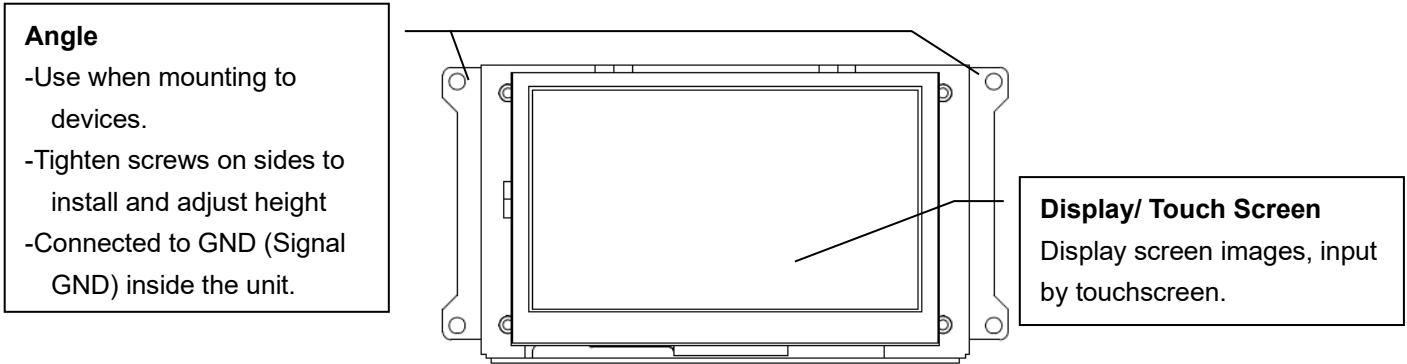

■ Back Side

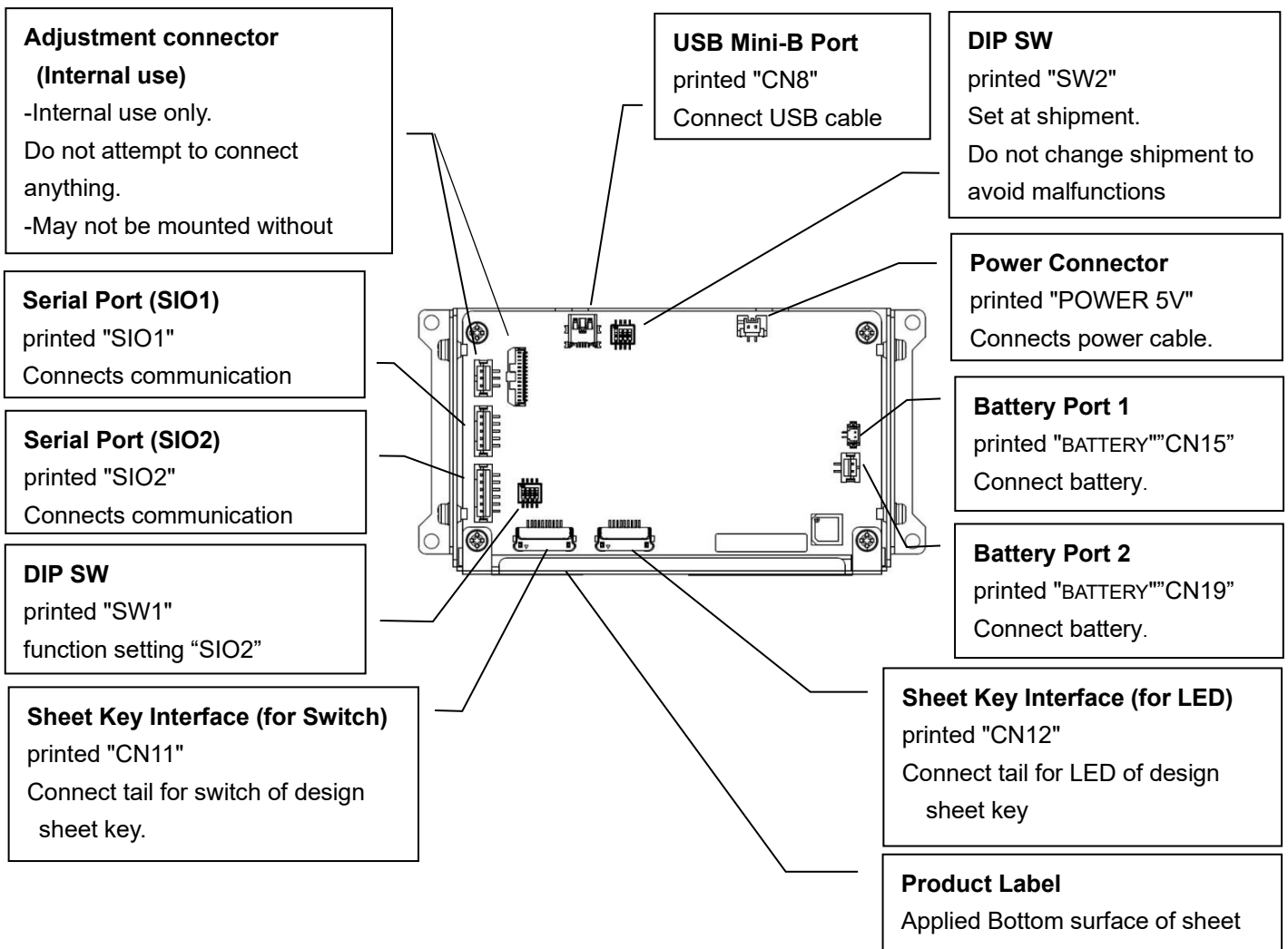

7. Installation and Wiring

7-1 Installation

- Make sure that power is not applied when installing and/or wiring.
- Refer to the panel opening example and the attached outline diagrams when designing the chassis.
- Design the chassis so that there will be no contorting or deformation when installing.
- Make sure cables from the LCD do not come in contact with the structure and is not subject to stress.

7-2 Installation

7-2-1 Panel Opening Example

Below is the panel opening dimension example for when applying sheets and etc. to the surface by opening the entire touch screen surface.

Design the chassis accordingly to the actual installing method.

- When using the design sheet key, a tail opening that suits the design sheet key is necessary.

*Diagram from the front side of panel (panel thickness: 1.6mm or less).

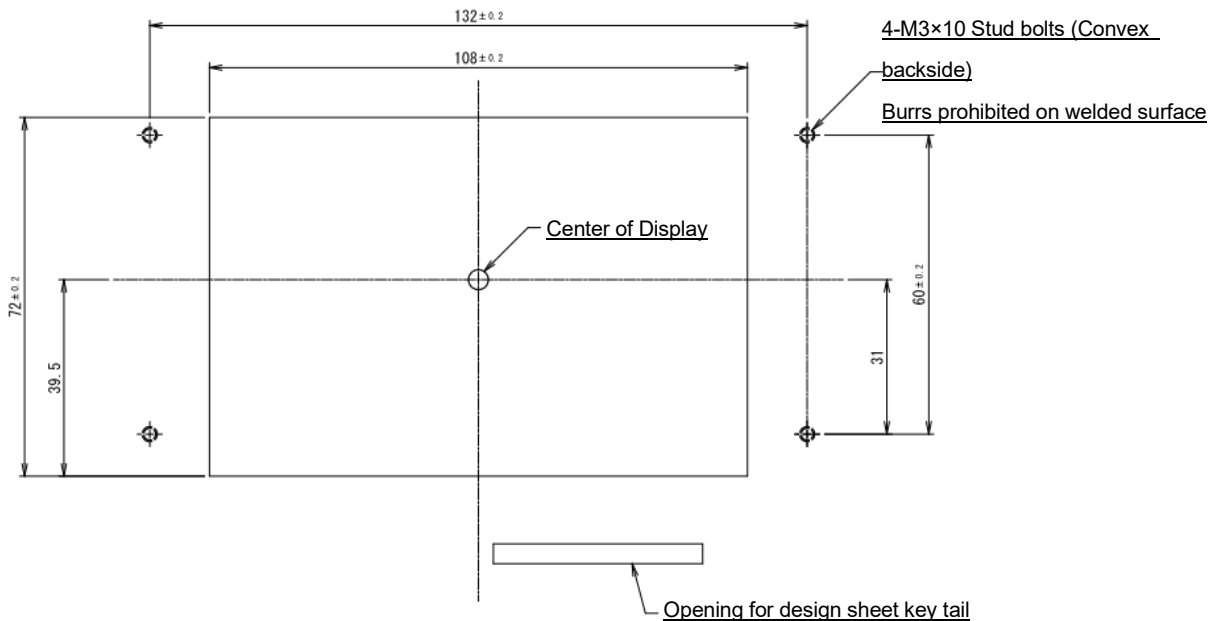

❗ Design the opening of the design sheet key tail in the diagram according to the design sheet key to be used.

❗ To avoid damage to the design sheet key tail, do not directly come in contact with the edge of the panel opening. If damaged, it may cause a switch or an LED performance defect.

7-2-2 Panel Mounting Procedures

- (1) Align the hole of the unit angle with the stud bolts of the panel in 4 locations and tighten the nuts.

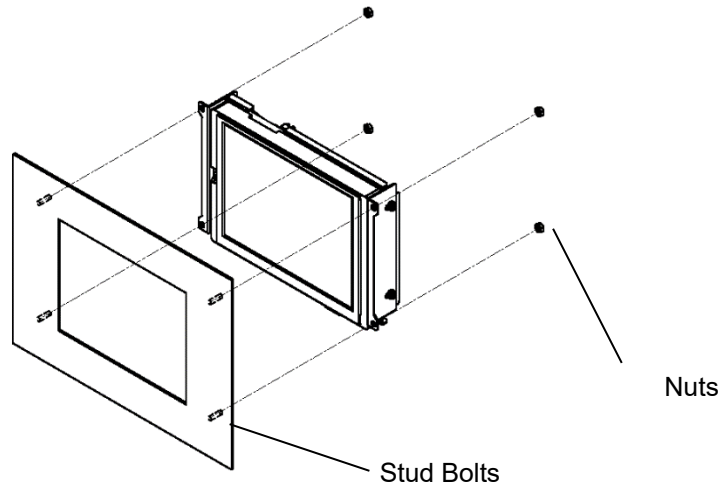

- (2) Adjust the height of the touch screen (LCD) with the angle.

■ Panel Opening Example

Design and arrange the design so that the touch screen is a little inward (about 0.3mm recommended) from the sheet side so that the sheet side does not push the touch screen.

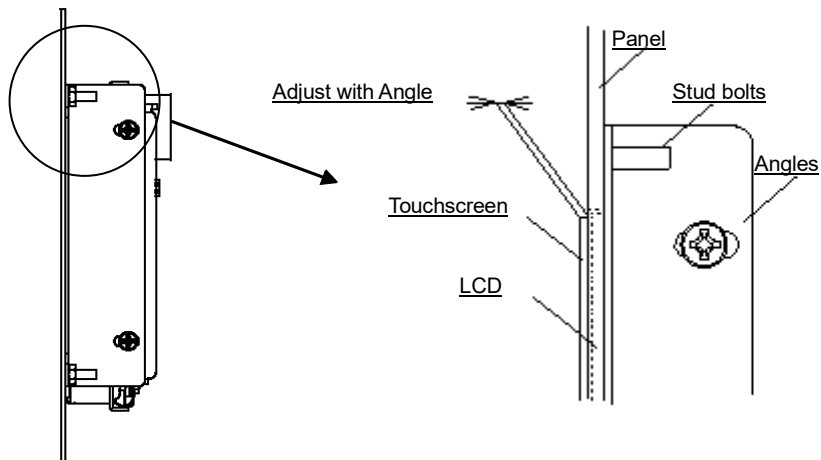

- (3) Pull the tail of the design sheet key through the opening of the panel and apply the design sheet key so that the display center and the transparent window of the design sheet key are aligned. To avoid getting air bubbles between the panel and the design key, apply to one side and carefully work to the other by lightly pressing down with your hands or a rubber roller.

❗ To avoid damage to the design sheet key tail, do not directly come in contact with the edge of the panel opening. If damaged, it may cause a switch or an LED performance defect.

❗ The tail should be folded so it forms an "R" and is not folded flat.

- If only the display area (touchscreen key area) is opened:
Adjust so that there is a 0.5mm gap between the inside of the panel and the upper electrode of the touch screen.

7-3 Wiring Procedure

Please follow the Instructions of each number when wiring.

Apply power after all wirings are done; do not attempt to do the wiring with the power on.

All wirings do not need to be connected; connect only the ones necessary for the application to be used.

7-3-1 Wiring Location

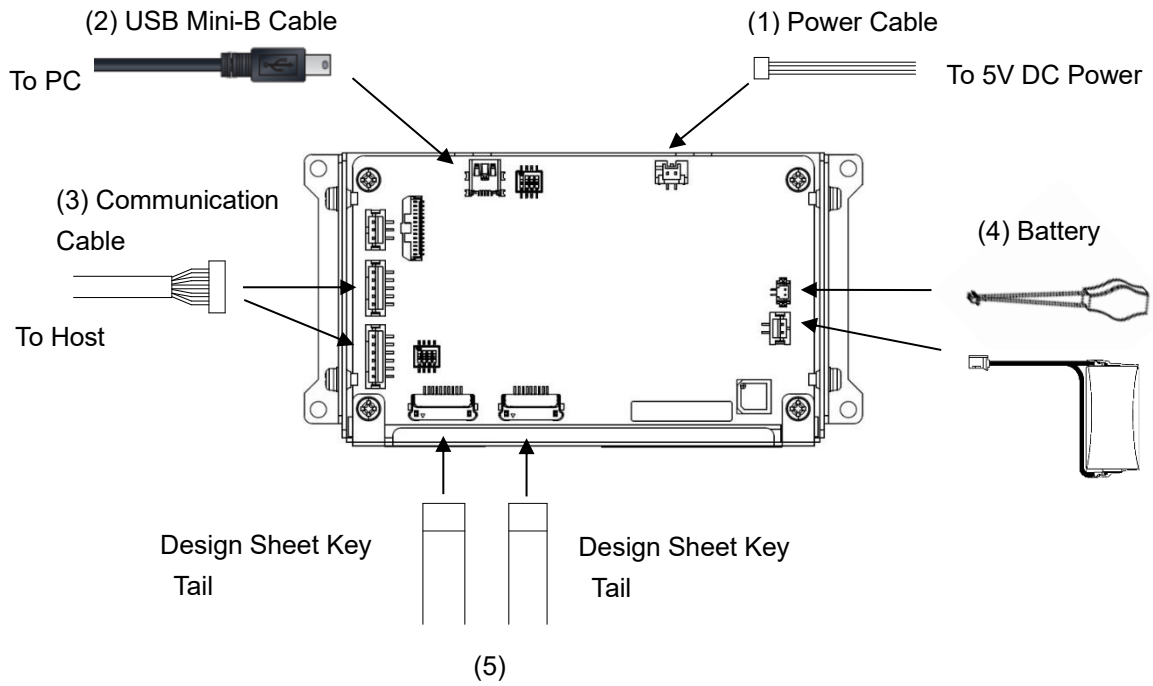

7-3-2 Connecting Unit to Power

- Connecting to 5V DC Power
Use a Power Cable to connect to 5V DC.

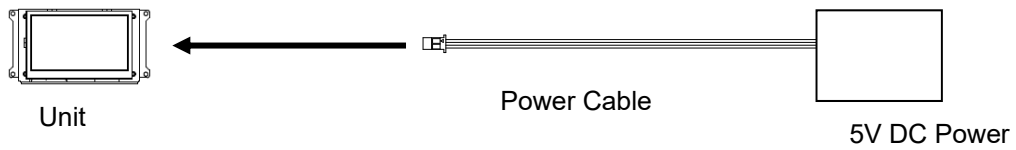

《Power Specification》

- 5VDC±5%

《Power Cable Specification》

- Compatible connector housing: PAP-02V-S (Japan Solderless Terminal)
Contact pin: SPHD-001T-P0.5、SPHD-002T-P0.5

- Pin Assignment

Pin No	Signal
1	+5V
2	GND

*GND (Signal GND) and frame (sheet metal) are connected inside the unit.

- ❗ Power Cable should be connected by shorter route than switching power.
- ❗ Be sure to wire separately by sequence the input-output device, power device, and power of InfoSOSA.
- ⌚ Do not turn the power OFF while the unit is booting.

7-3-3 Connecting to USB Mini-B Cable

Connect to the PC's USB port and download the screen data.

When not downloading screen data, connection of USB mini-B cable is unnecessary.



7-3-4 Connecting to Communication Cable

Connect to Serial port (SIO1:RS232C, SIO2:RS422/485) of the host.

Connect to a PC if downloadscreen data.

SIO1 can be used for host communication and download screen data.

SIO2 can be used for host communication.

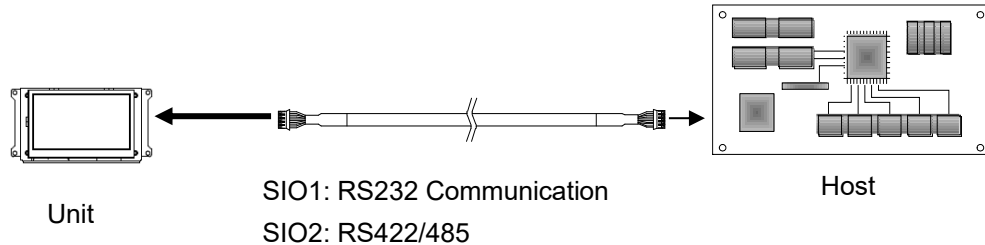

*Applying Ferrite Core to the communication cable is recommended for noise and static measures.

《SIO1 Specification》

- Compatible connector housing: PHR-5(Japan Solderless Terminal)
Contact pin: SPH-002T-P0.5S
- Pin Assignment

Pin No	Signal	Direction
1	RXD	InfoSOSA ← Host (TXD)
2	TXD	InfoSOSA → Host (RXD)
3	GND	-
4	RTS	InfoSOSA → Host (CTS)
5	CTS	InfoSOSA ← Host (RTS)

【Caution】

- When communicating the PC and the InfoSOSA, communication error might occur according to the output signal level of the serial port (COM) of the PC. Please use an USB serial conversion cable if error does occur.

《SIO2 Specification》

- Compatible connector housing: PHR-6(Japan Solderless Terminal)
Contact pin: SPH-002T-P0.5S
- Pin Assignment

Pin No	RS422		RS485	
	Signal	Direction	Signal	Direction
1	TXD+	InfoSOSA -> Host	DATA+	InfoSOSA <-> Host
2	TXD-	InfoSOSA -> Host	DATA-	InfoSOSA <-> Host
3	GND	-	GND	-
4	RXD+	InfoSOSA <- Host	(DATA+)	Internally connected to pin 1
5	RXD-	InfoSOSA <- Host	(DATA-)	Internally connected to pin 2
6	GND	-	GND	-

7-3-5 Connecting to Battery

Connect if battery backup of RTC is necessary.

*There are two battery interfaces. If a battery is connected to either of them, backup is possible.

If you do not need to back up, you do not need to connect a battery.

《Battery Port 1》

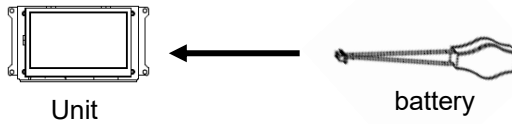

- Compatible connector housing: DF13C-2P-1.25V(Hirose electric)
- Pin Assignment

Pin No	Signal
1	+
2	-

《Battery Port 2》

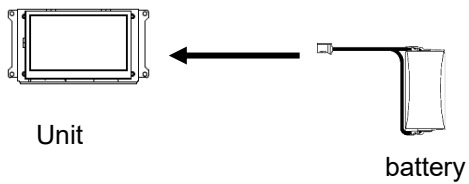

- Compatible connector housing: PHR-2 (Japan Solderless Terminal)
- Pin Assignment

Pin No	Signal
1	+
2	-

❗ When inserting a battery, check the + and - poles to avoid incorrect insertion.

❗ Dispose of used batteries according to law.

7-3-6 Connecting Design Sheet Key Tail

Connect the Design sheet key tail to the connector by below procedure.

- (1) Open the holding lid by sliding to the direction as below by hand.

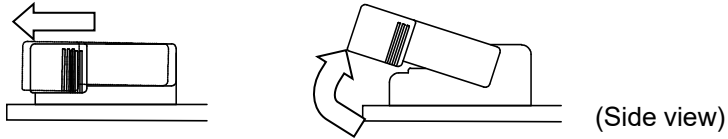

- (2) Hold the tail so the conductive side of the tail is placed downwards and the reinforcement plates are upwards. Insert as far as possible.

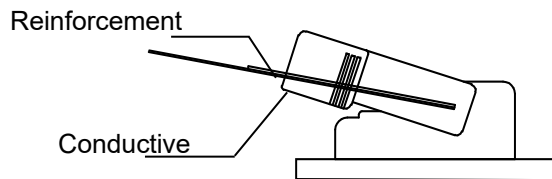

- (3) After inserting the tail, press down the lid and slide it towards the direction of the arrow shown below.

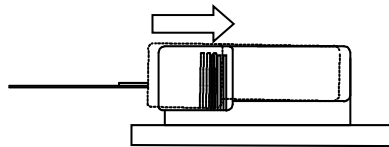

7-4 Mounting Conditions

- When mounting, be sure to have enough room between the unit, structure and part and also consider the operation temperature.
- Be sure that the ambient operating temperature and the ambient humidity are within their designated ranges.

(Ambient operating temperature indicates the temperature of both the display side and inside the cabinet.)

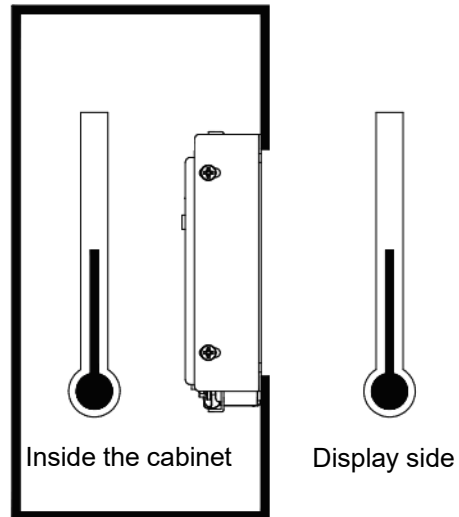

8. Starting the InfoSOSA

Make sure all the wirings are complete and turn ON the 5V DC power.

A starting beep will sound.

Download the screen data to the unit.

For downloading instructions, please refer to the "IS731 Series Start-up Guide".

9. Starting the Development Tool (InfoSOSA Builder)

InfoSOSA will need to be installed to set and edit screens of the InfoSOSA.

Once the installation is complete, an icon will appear on the desktop.

Start the InfoSOSA Builder from the icon and set up or edit screens of the InfoSOSA.

Please refer to the "IS731 Series Start-up Guide" for installing, set-up, and operating procedure details.

10. Maintenance

10-1 Display Maintenance

If the surface of the display or the frame becomes dirty, wipe clean with a soft cloth dampened with thinned neutral detergent and wrung dry.

⊘ Use of thinner, organic solvents and strong acidic solvents are prohibited.

10-2 Regular Inspections

Please conduct an inspection on a regular basis to use the InfoSOSA in its best condition.

Ambient Environment Check

- (1) Ambient temperature is within the specified range (0 to 55 degrees Celsius).
- (2) Ambient humidity is within the specified range (10 to 90%RH).
Absolute humidity must be $T=40$ degrees Celsius , 90%RH or lower when $T>40$ degrees Celsius.

Electrical Specification Check

- (1) Voltage is within the allowance range (5VDC \pm 5%).
- (2) Battery check

Installation Check

- (1) Make sure the connector of the connecting cable is fully inserted.
- (2) Make sure the product is securely installed and not loose.

Touchscreen Calibration Check

- (1) Conduct calibration if the coordinates of the touchscreen is not correct.
Touchscreen calibration function needs to be set with the InfoSOSA Builder.
Please refer to "IS731 Series Start-up Guide" and "Reference Manual" for more information on how to setup.

11. Warranty and Repairs

11-1 Repairs

Feel free contact us if you have any questions or need to talk to someone concerning repairs of our products, but before you do, check the problems and phenomenon beforehand. Please enclose a “repair request” with the phenomenon noted when you send us the product, and be sure to take precautions when packaging the product to prevent further damage during shipment.

11-2 Warranty

The warranty period is limited to 12 months (1 year) from the date of shipment. Warranty for any repair needed to the same repaired part of the same product is three months. Any defects that occur upon normal use under conditions specified herein will be repaired (factory repair) free of charge.

You will be liable for all repair fees even within the warranty period for any conditions listed below:

- (1) Any malfunctions, defects, and/or damages that occurred during transport, transfer, or mishandling by the user after delivery
- (2) Any malfunctions, defects, and/or damages caused by natural or man-made disaster.
- (3) If the product is used under any condition, in any environment, or by any method other than those specified in the specifications, catalogs, manuals, notes, and/or other documents.
- (4) Any replacement of consumables.
- (5) If the product is repaired, remodeled, modified, or disassembled by a party other than DMC.

This warranty covers only the product itself. And damages driven by the failure of our product and repairs and/or replacements done on-site will not be covered.

11-3 Production Discontinuance

In the event of production discontinuance, an announcement will be made on our guidance six months prior to the last possible order reception date.

11-4 Repair Warranty

- (1) Only products we manufacture are covered for repair warranty. This warranty is not valid for options.
- (2) Your programs and data might be lost during repairs, so please take back-ups of data beforehand. Also, note that we will not be held liable for any programs and/ or data lost during repairs.
- (3) We will take utmost care of your data stored in our product but please be sure to delete any confidential data beforehand.
- (4) Repairs will be made in our factory in principle and shipping cost will be borne by the customer.
- (5) All ownership of the repaired parts will belong to DMC.

12. Others

If you have comments or questions, feel free to contact us.

North South America area

✉ technical-global@dush.co.jp

Asia Pacific area

✉ technical-global-asia@dush.co.jp

Europe, Middle East, Africa area

✉ technical-global-eu@dush.co.jp

FAQ

 www.dush.co.jp/english/support/faq

2nd Edition February 2024

DMC Co., Ltd.

Office hours: 9:00 - 17:00 weekdays

(except Saturdays, Sundays, national holidays, and year-end and New Year holidays)

URL: <https://www.dush.co.jp/english/>

This product and document are protected by the copyright law.

Photocopying, duplicating, reproducing, and modifying of this product or document in part or by whole is prohibited.

Copyright(C) 2024 DMC Co., Ltd. All Rights Reserved