

Contents in this document may change without prior notice.
Please obtain the delivery specification for the final design.



EM Series
10.1" Wide
24VDC
Open Frame Panel Computer
With Linux Embedded Touch Screen

EM8/EMG8

Model: EM8-W310A7-0024-207
EMG8-W310A7-0024-207

Product Specification

Table of Contents

1.	Summary.....	3
2.	Product Model.....	3
3.	Packaging Specification	3
4.	Specification.....	4
4-1	Functions	4
4-2	Display.....	5
4-3	Touch screen.....	5
4-4	General Specification	6
4-5	Environment.....	6
4-6	Installation.....	6
4-7	Name of Parts	7
4-8	External Interface	9
4-8-1	microSD Card Slot.....	9
4-8-2	Serial Interface (SIO1/SIO2)	9
4-8-3	Ethernet.....	10
4-8-4	USB Host Interface.....	10
4-8-5	USB Device Interface	10
4-8-6	DIO Interface	11
4-8-7	SPI/PWM Audio Interface	12
4-8-8	Power Connector.....	12
4-8-9	Battery Interface	13
4-8-10	Default Switch Setting at Shipment.....	13
4-9	Linux OS	14
4-9-1	Application Software Development Environment	14
4-9-2	Embedded Application.....	14
4-9-3	IS-APP	14
5.	Installation	15
5-1	Installing Condition.....	15
5-2	Panel Opening Example.....	15
6.	Product Label	16
7.	Complying Standards	16
7-1	RoHS Directives.....	16
8.	List of Options	17
9.	Warranty.....	18
9-1	Warranty Period	18
9-2	Warranty Exceptions	18
10.	Product Discontinuance.....	18
11.	Others	19

Appendix

Outline Diagram: SM3-002153-10 • SM3-002328-10

1. Summary

This is a panel computer with 10.1" LCD and touch screen.

Touch screen lineup includes analog resistive type and projective capacitive type touch screens.

The product will be referred to as EM8 hereinafter.

2. Product Model

Model	Specification			
	LCD Size	Touch screen Type	Power	HMI Application
EM8-W310A7-0024-207	10.1"	Analog Resistive	24VDC	IS-APP *1
EMG8-W310A7-0024-207	10.1"	Projective Capacitive	24VDC	IS-APP *1

*1 When using HMI application 'IS-APP (InfoSOSA Application)' please purchase the development kit (SWDK-101).

For more information on 'IS-APP (InfoSOSA Application)' please refer to IS-APP Start-up Guide.

3. Packaging Specification

Contents	Specification	Packaging Box Dimensions
EM8-W310A7-0024-207	5 units/box *1	356(W) x 356(D) x 210(H) mm
EMG8-W310A7-0024-207	5 units/box *1	302(W) x 302(D) x 260(H) mm

*1: Maximum unit per box: 5 units

4. Specification

4-1 Functions

Items		Specification	
		EM8-W310A7-0024-207	EMG8-W310A7-0024-207
CPU		i.MX6ULL 792MHz (ARM Cortex-A7 Single Core) by NXP	
RAM		DDR3-SDRAM 512MB	
ROM		NAND Flash 512MB	
Interface	Serial	SIO1	RS232C: 1CH (5 pin nylon connector)
		SIO2	RS422/485: 1CH (6 pin nylon connector) Terminal resistance: 120Ω
	Ethernet		Ethernet 10BASE-T/100BASE-TX: 1CH
	microSD Card ^{*1}		microSD/ SDHC Card slot: 1CH
	USB host ^{*2}		USB2.0: 1CH (TYPE-A connectors) USB devices that can be used: keyboard, mouse (HID Class), USB memory (Mass Storage Class)
	USB device		USB2.0: 1CH (mini TYPE-B connectors)
	DIO		DIN: 4 points (non-isolated TTL Schmitt Trigger input) DOOUT: 4 points (non-isolated open collector output) (12 pin Nylon Connector)
	SPI/PWM Audio		SPI/PWM Audio OUT: 1CH (7pin Nylon connector) SPI and PWM audio cannot be used at the same time.
	Buzzer		On board
	RTC ^{*3}		RTC with battery backup Error at time of backup: ±65 seconds/ month (at ambient temperature of 25°C)

*1 Does not guarantee accurate operation for all SD memory cards available in the market.

*2 Does not guarantee accurate operations for all USB devices available in the market.

*3 Above chart shows RTC with battery backup embedded on the EM8.

EM8 normally uses the timer in the CPU for time display.

If time according to the specification is needed, please refer to the RTC embedded in the EM8.

When using in a system where time error causes issues, please set to correct the time on a regular basis.

4-2 Display

Items		Specification	
		EM8-W310A7-0024-207	EMG8-W310A7-0024-207
Display	Device	10." TFT LCD	
	Resolution	1024(W)×600(H)	
	Color	65,536 colors	
	Backlight	LED backlight (not replaceable)	
	Brightness	360cd/m ²	400cd/m ²
	Backlight brightness adjustment	Adjustable in 8 levels	
	Backlight life ^{*1}	50,000 hours average	

*1 Time until brightness declines by 50% from the initial value at maximum brightness in ambient temperature of 25°C.

4-3 Touch screen

Items		Specification	
		EM8-W310A7-0024-207	EMG8-W310A7-0024-207
Method	Analog resistive	Projective capacitive	
Input Method	Finger	Finger	
Maximum number of simultaneous inputs	1 point	2 points ^{*1}	
Operating life	Continuous typing (finger input): 1000000 times	Continuous typing (finger input): 5000000 times	

*1 Application for two-point simultaneous input of touch screen must be made by the customer.

Note: For analog resistive touch screens, please perform coordinate calibration when installing to a device in order to use it accurately.

The projective capacitive touch screens of EM8 have auto-calibration function and will automatically calibrate according to the environment installed. However, please note it may not adapt to all installed environments.

If the touch screen operations become unstable, please reconsider the environment in which it is installed.

Touch operation may not operate accurately if the surface of the touch screen is wet.

Please wipe the surface of the touch screen before use.

4-4 General Specification

Items		Specification	
		EM8-W310A7-0024-207	EMG8-W310A7-0024-207
Power	Rated voltage	24VDC	
	Voltage tolerance	24VDC±20%	
	Power consumption *1	MAX 6W, TYP 4.5W	
	FG connection	GND (Signal GND) and FG (Frame GND) are connected inside the unit.	

*1 Power consumption of the EM8 unit only. Please consider the power consumption of the USB device when using the USB.

Note: If power supply with slow rising and falling of power is used, it may not operate properly.

Also, when rebooting the EM8, leave the power OFF for a certain period of time after turning the power OFF and avoid turning the power back ON immediately. If failed to do so, it may not start up accurately.

4-5 Environment

Items		Specification	
		EM8-W310A7-0024-207	EMG8-W310A7-0024-207
Ambient operating temperature (Inside cabinet and display side)		-10 to 60°C	
Ambient storage temperature		-20 to +80°C	
Ambient operating humidity		10 to 90%RH (Non-condensing. Wet-bulb temperature is 39 °C or less)	
Ambient storage humidity		10 to 90%RH (Non-condensing. Wet-bulb temperature is 39 °C or less)	
Dust		0.1mg/m ³ or under (Conductive dust is prohibited)	
Corrosive Gas		Corrosive gas prohibited	
Environment		Pollution Degree 2, for Indoor use	
Pressure resistance (Altitude)		800 to 1114hPa (Altitude of 2000m or lower)	
Vibration resistance		5 to 9Hz Single amplitude 3.5mm 9 to 150Hz Fixed acceleration 9.8m/s ² X, Y, Z each direction 10 times (100 minutes) (JIS B 3502, IEC61131-2 compliant)	

4-6 Installation

Items		Specification	
		EM8-W310A7-0024-207	EMG8-W310A7-0024-207
Grounding		Functional grounding : D type ground	
Structure		Open frame	
Cooling		Natural cooling	
Weight		App. 770g	App. 780g
External Dimensions		244(W) x 147(H) x 32.4(D) mm	244(W) x 147(H) x 32.7(D) mm (Excluding touch pane tail protrusions)
Outline diagram		SM3-002153-10	SM3-002328-10

4-7 Name of Parts

■ Backside: EM8-W310A7-0024-207

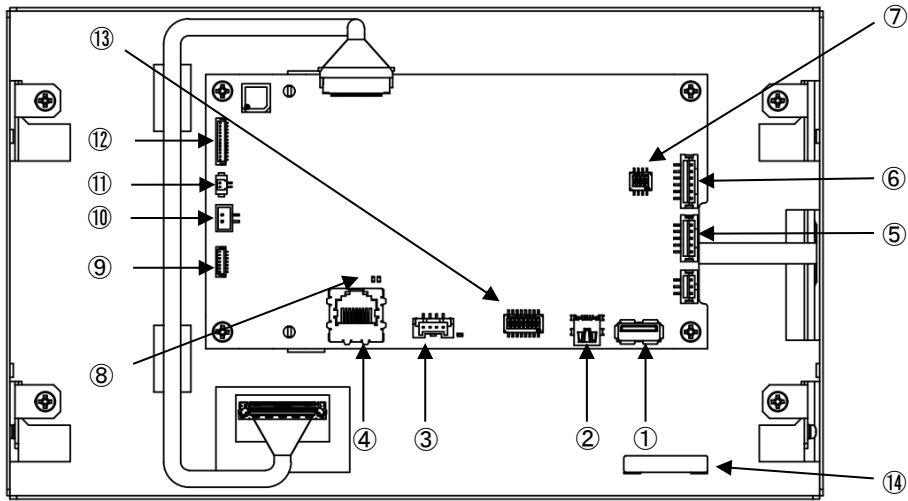

■ Backside: EMG8-W310A7-0024-207

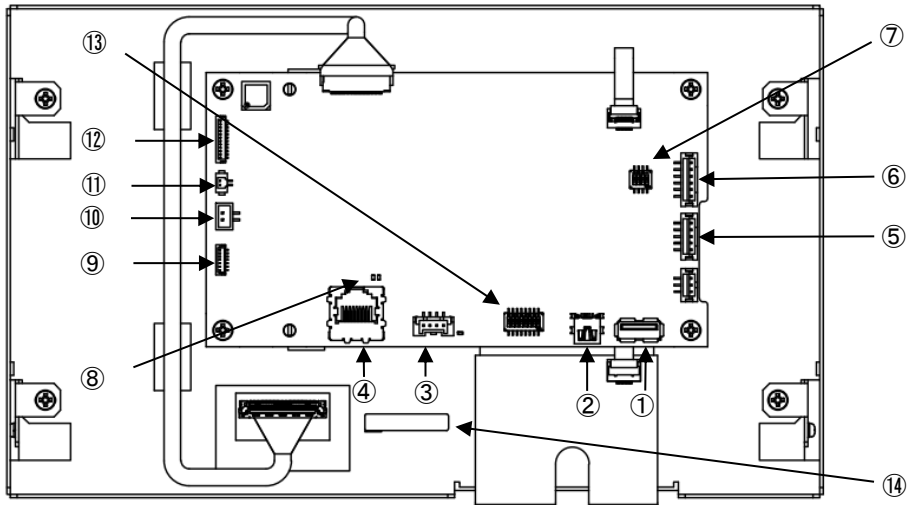

- | | |
|-------------------------|---------------------------|
| ① USB Host Interface | ⑧ LAN Status LED |
| ② USB Device Interface | ⑨ SPI/PWM Audio Interface |
| ③ Power Input Interface | ⑩ Battery Input 2 |
| ④ Ethernet (LAN) | ⑪ Battery Input 1 |
| ⑤ Serial Port (SIO1) | ⑫ DIO Interface |
| ⑥ Serial Port (SIO2) | ⑬ Shipping Setting Switch |
| ⑦ SIO2 Setting Switch | ⑭ Product Label |

■ Bottom side: EM8-W310A7-0024-207

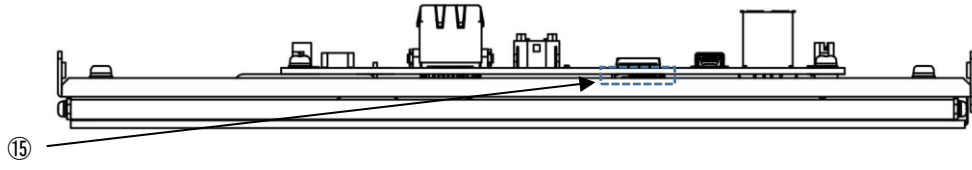

■ Bottom side: EMG8-W310A7-0024-207

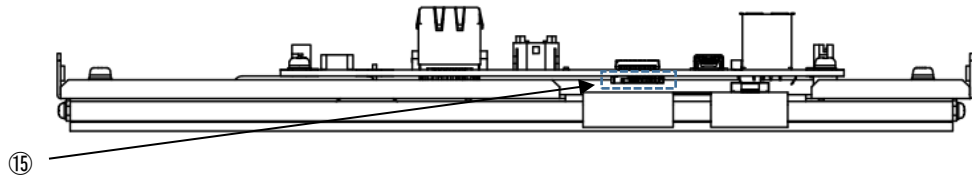

⑮ microSD Card Slot

4-8 External Interface

4-8-1 microSD Card Slot

Connectors: microSD card slot (Push-in/out method)

Corresponding media: microSD/SDHC memory card

Maximum capacity: 32GB

4-8-2 Serial Interface (SIO1/SIO2)

(1) Serial port (SIO1): RS232C

Connectors: Nylon connectors

Model: Equivalent to B5B-PH-SM4-TB (by JST)

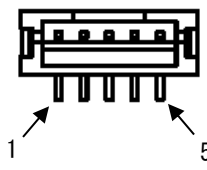
PIN No	Signal	Schematic Diagram
1	RXD	
2	TXD	
3	GND	
4	RTS	
5	CTS	

(2) Serial port (SIO2): RS422/485

Connectors: Nylon connectors

Model: Equivalent to B6B-PH-SM4-TB (by JST)

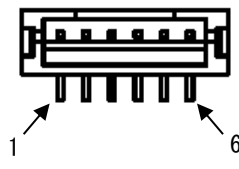
PIN No	Signal		Schematic Diagram
	RS422	RS485	
1	TX+	DATA+	
2	TX-	DATA-	
3	GND	GND	
4	RX+	(DATA+) ^{*1}	
5	RX-	(DATA-) ^{*2}	
6	GND	GND	

*1 Connected to pin 1 inside the product.

*2 Connected to pin 2 inside the product.

RS422/485 can be set with the SIO 2 setting switch.

Default setting at shipment of EM8 is "RS485 Terminal resistor enabled".

PIN No	RS422	RS485	Contents
1	ON/OFF		ON: Terminal resistor 120Ω enables OFF: Terminal resistor disabled
2	OFF	ON	RS422/485 Setting
3	OFF	ON	
4	OFF	ON	

4-8-3 Ethernet

Port: Ethernet 10BASE-T/100BASE-TX

Connectors: RJ-45

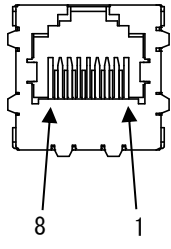
PIN No	Signal	Schematic Diagram
1	TX+	
2	TX-	
3	RX+	
4	NC *1	
5	NC *1	
6	RX-	
7	NC *1	
8	NC *1	

*1 NC stands for 'not connected'.

Status LED

GREEN: LINK/ACT

YELLOW: SPEED

* Status LED is located on the board.

Supporting cable: Above category 5

4-8-4 USB Host Interface

Port: USB2.0

Connectors: Type-A Connectors

Maximum supply current: 0.5A

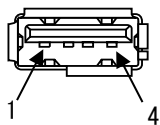
PIN No	Signal	Schematic Diagram
1	USB_VCC	
2	D-	
3	D+	
4	GND	

4-8-5 USB Device Interface

Port: USB2.0

Connectors: Type-B Mini Connectors

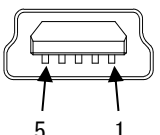
PIN No	Signal	Schematic Diagram
1	USB_VCC	
2	D-	
3	D+	
4	NC *1	
5	GND	

* NC stands for 'not connected.'

4-8-6 DIO Interface

Port: DIO

Connectors: Nylon connectors

Model: Equivalent to BM12B-SRSS-TBT (by JST)

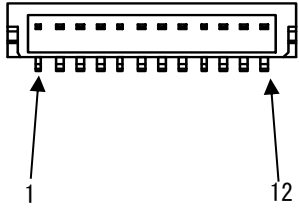
PIN No	Signal	Schematic Diagram
1	DIN1	
2	DIN2	
3	DIN3	
4	DIN4	
5	GND	
6	GND	
7	DO_COM+	
8	DOUT1	
9	DOUT2	
10	DOUT3	
11	DOUT4	
12	DO_COM- (GND)	

◇DIN Specification

Input specification: non-isolated TTL Schmitt Trigger input

Input points: 4

Input voltage: +5VDC

Input resistance: Pull-up 10kΩ

Input circuit:

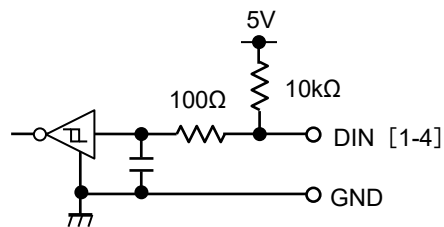

◇DOUT Specification

Output specification: non-isolated open connector output

Output points: 4

Output voltage: Maximum +5VDC

Output current: Maximum 50mA (per point)

Output circuit:

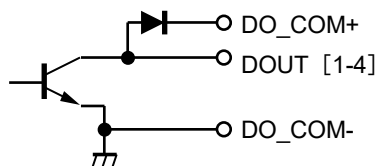

DO_COM- is connected to GND inside.

4-8-7 SPI/PWM Audio Interface

Port: SPI/PWM audio

Connectors: Nylon Connectors

Model: Equivalent to BM07B-SRSS-TBT (by JST)

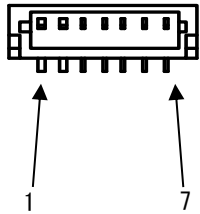
PIN No	Signal		Schematic Diagram
	SPI	PWM audio	
1	CLK	-	
2	GND	GND	
3	CS	-	
4	MISO	-	
5	MOSI	MQS_RIGHT	
6	GND	GND	
7	5V OUT	5V OUT	

* SPI and PWM audio cannot be used at the same time.

◇SPI specification

In/Output signal level: Non-isolated LVTTTL (3.3V)

◇PWM audio specification

Audio output using MQS (Medium Quality Sound) function of the CPU.

Only RIGHT(1CH) can be used for output.

Amplifier is not built in.

Please refer to below diagram for how to connect the amplifier and/or speaker.

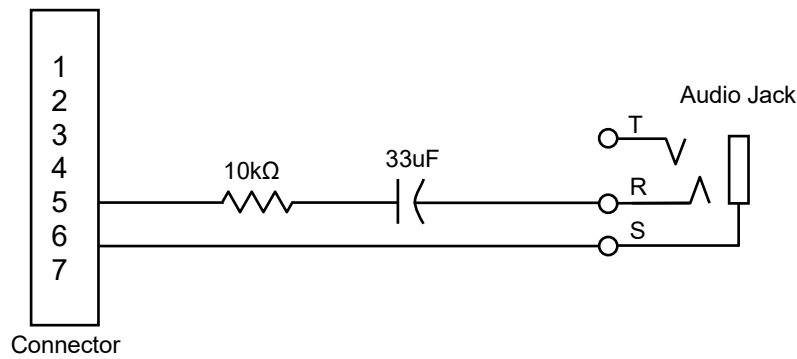

4-8-8 Power Connector

Port: 24VDC IN

Connectors: Nylon Connectors

Model: Equivalent to BM04B-PASS-1-TFT (by JST)

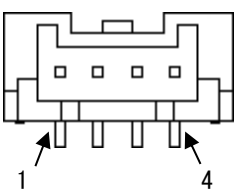
PIN No	Signal	Schematic Diagram
1	GND	
2	24V DC	
3	(24V DC) *1	
4	(GND) *2	

*1 Connected to pin 2 inside EM8.

*2 Connected to pin 1 inside EM8.

4-8-9 Battery Interface

There are two interface connectors for the battery. When both are connected, the one with the higher voltage will take precedence.

Use the primary battery and with nominal voltage of 3VDC.

Do not apply voltage higher than 3.6VDC. Backup current is TYP. 60µA.

(1) Battery Interface 1

Connectors: Nylon Connectors

Model: Equivalent to DF13C-2P-1.25V (21) (by Hirose Electric)

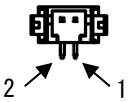
PIN No	Signal	Schematic Diagram
1	+	
2	-	

* Complying battery: CR2032WK11 [capacity 220mA / h] (by Maxell)

* Batteries other than the above complying battery can be used if it is a primary battery with nominal voltage of 3VDC.

(2) Battery Interface 2

Connectors: Nylon Connectors

Model: Equivalent to B2B-PH-SM4-TB (by JST)

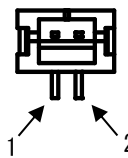
PIN No	Signal	Schematic Diagram
1	+	
2	-	

* Complying battery: CR-2/3AZC22P [capacity 1,600mA / h] (by Panasonic)

CR17450 A WK 41 [capacity 2,500mA / h] (by Maxell)

CR17450 A 2WK 35 [capacity 5,000mA / h] (by Maxell)

CR17335 A WK 11 [capacity 1,650mA / h] (by Maxell)

* Batteries other than the above complying battery can be used if it is a primary battery with nominal voltage of 3VDC.

4-8-10 Default Switch Setting at Shipment

Below is the switch setting at factory shipment. Changing the switch setting by the customer is prohibited.

EM8 setting at shipment.

Shipment switch setting

No	1	2	3	4	5	6	7	8
Setting	OFF	ON	ON	OFF	ON	OFF	OFF	ON

4-9 Linux OS

This describes the Linux OS embedded in the EM8.

For details, please refer to the EM series software development manual.

We can provide the software development environment (DVD).

Please contact us via e-mail for the DVD.

4-9-1 Application Software Development Environment

Qt application is recommended.

4-9-2 Embedded Application

Below is the specification of Linux embedded in the EM8.

Items		Specification
Glibc version		2.23
On-board Software	Qt5.7.1	GUI tool kit
	PCMan File Manager	File manager
	GTK+	GIMP Toolkit library
	bash	Bash shell
	busybox	Program with Linux basic commands gathered in one file.
	udhcpd	DHCP client
	gdbserver	Gdb debugger that can connect from host
	ntpd	Time synchronization by NTP
	Lighttpd	Web server (complying to php and cgi)
	x11	X Window system
	x11vnc	VNC server/client
	LXTerminal	Terminal emulator
	ALSA	Audio mixer
	emg-setting	EMG setting tool
	florence	Screen keyboard
	leafpad	Text editor
	openssh	SSH server
libmodbus	Modbus library	
FZLanTingHei-R-GB18030	RICHO (GB18030) font	

* Please refer to "EM Series Software Development Manual" for details.

4-9-3 IS-APP

Our IS-APP (application version of InfoSOSA) can be embedded to the EM8 as HMI application.

Please purchase the "Development Kit (SWDK-101)" when using the IS-APP.

For details, please refer to "IS-APP Start-Up Guide."

5. Installation

5-1 Installing Condition

- When mounting to panels, be sure to have enough room for inserting and removing of microSD cards and cables.
- Please ensure ventilation and consider the specification temperature between EM8 and the structures and parts when installing the EM8.
- Be sure to use at ambient temperature of -10 to 60°C, ambient humidity 10 to 90%RH (wet-bulb temperature 39°C or less).

(Ambient operating temperature indicates both the display side and inside of cabinet where the EM8 will be installed.)

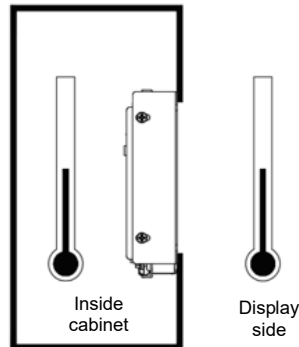

5-2 Panel Opening Example

Below is the panel opening dimension example for when applying sheets and etc. to the surface by opening the touch screen surface.

*Front panel view (board thickness $t=1.6\text{mm}$ or less)

■ EM8-W310A7-0024-207

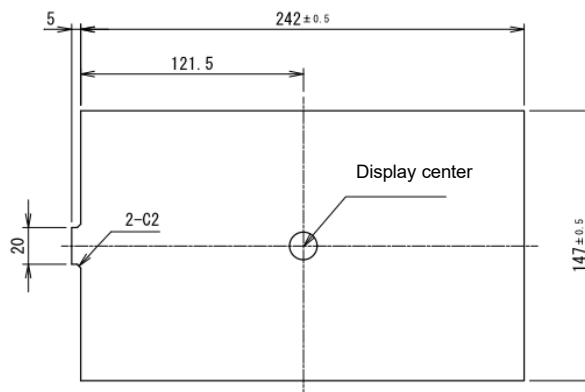

UNIT: mm

■ EM8-W310A7-0024-207

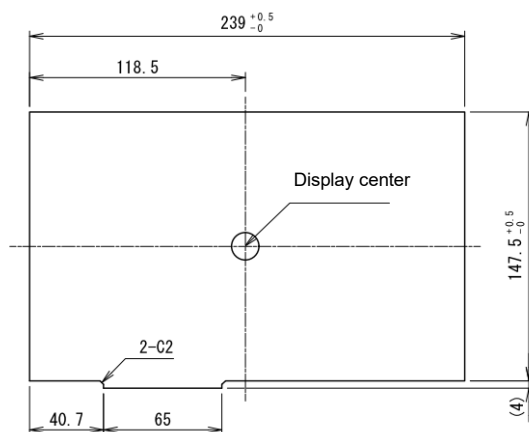

UNIT: mm

6. Product Label

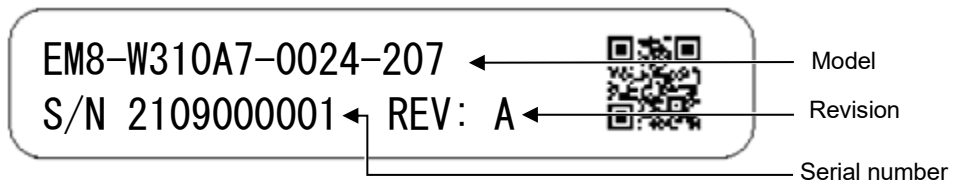

Above is an example image of the product label.

The following information will be noted on the label of the actual product.

- Model : Model of the product purchased
- Serial number : 10 digit control number
- Revision : Alphabet (1 character from A to Z) according to the latest revision.

7. Complying Standards

7-1 RoHS Directives

Compliant to EU RoHS Directives.

8. List of Options

■ Development Kit

Model	Specification
SWDK-101	24VDC Power unit InfoSOSA Development Kit Data Download Guide *1

*1 Needed when using InfoSOSA (IS-APP) application

■ Serial Communication Cable

Model	Specification
ISCBL-S02-001	RS232C Cable Nylon Connectors 5P-D sub (2000mm)
ISCBL-S03-001	RS232C Cable Nylon Connectors 5P-Cut end (500mm)
SWHC-T2-001	RS422 Cable Nylon Connectors 6P- Cut end (500mm)
SWHC-T3-001	RS485 Cable Nylon Connectors 6P-Cut end (500mm)

■ Power Supply Cable

Model	Specification
SWHC-P1-001	Power supply cable Nylon Connectors 4P-Round terminal (500mm)

9. Warranty

9-1 Warranty Period

The warranty period is limited to 12 months (1 year) from the date of shipment. Warranty for any repair needed to the same repaired part of the same product is three months. Any defects that occur upon normal use under conditions specified herein will be repaired (factory repair) free of charge.

Any defected parts under proper use will be examined by the supplier and replaced by the new parts if the defect is considered to be caused by the supplier.

The replacement is subject to be included in the next lot.

9-2 Warranty Exceptions

You will be liable for all repair fees even within the warranty period for any conditions listed below:

- (1) Any malfunctions, defects, and/or damages that occurred during transport, transfer, or mishandling by the user after delivery.
- (2) Any malfunctions, defects, and/or damages caused by natural or man-made disaster.
- (3) Any malfunctions and damages caused by static electricity.
- (4) If the product is used under any condition, in any environment, or by any method other than those specified in the specifications, catalogs, manuals, notes, and/or other documents.
- (5) Any replacement of consumables.
- (6) Any malfunctions, defects, and/or damages caused by associated equipment and/or usage of inappropriate consumables and media.
- (7) If the product is repaired, remodeled, modified, or disassembled by a party other than DMC Co., Ltd
- (8) If the product cannot be identified by a serial number.
- (9) Any malfunctions, defects, and/or damages that are to have been caused on your behalf.

This warranty covers only the product itself. Any damages, on-site repairs and replacement driven by the failure of the product will be decided upon discussion by both parties as necessary.

This product is structurally not repairable. All damaged parts are subject for replacement and freight will be charged.

10. Product Discontinuance

In the event of production discontinuance, an announcement will be made six months prior to the last possible order reception date.

11. Others

If you have comments or questions, please feel free to contact us.

North South America area

✉ technical-global@dush.co.jp

Asia Pacific area

✉ technical-global-asia@dush.co.jp

Europe, Middle East, Africa area

✉ technical-global-eu@dush.co.jp

FAQ

 www.dush.co.jp/english/support/faq/

5th Edition November 2023

DMC Co., Ltd.

Office hours: 9:00 - 17:00 weekdays

(except Saturdays, Sundays, national holidays, and year-end and New Year holidays)

URL: <https://www.dush.co.jp/english/>

This product and document are protected by the copyright law. Photocopying, duplicating, reproducing, and modifying of this product or document in part or by whole is prohibited.

Copyright(C) 2023 DMC Co., Ltd. All Rights Reserved

寸法許容差 呼び寸法 Nominal Dimensions	TOLERANCE
$L \leq 3$	± 0.4
$3 < L \leq 6$	± 0.48
$6 < L \leq 10$	± 0.58
$10 < L \leq 18$	± 0.7
$18 < L \leq 30$	± 0.84
$30 < L \leq 50$	± 1.0
$50 < L \leq 80$	± 1.2
$80 < L \leq 120$	± 1.4
$120 < L \leq 180$	± 1.6
$180 < L \leq 250$	± 1.85
$250 < L \leq 315$	± 2.1
$315 < L \leq 400$	± 2.3
$400 < L \leq 500$	± 2.5

SYM	改訂日 DATE	改訂内容 DESCRIPTION	ページ PAGE	担当 DESIGNED
	2020.09.29	新規図面登録	-	S. Takada

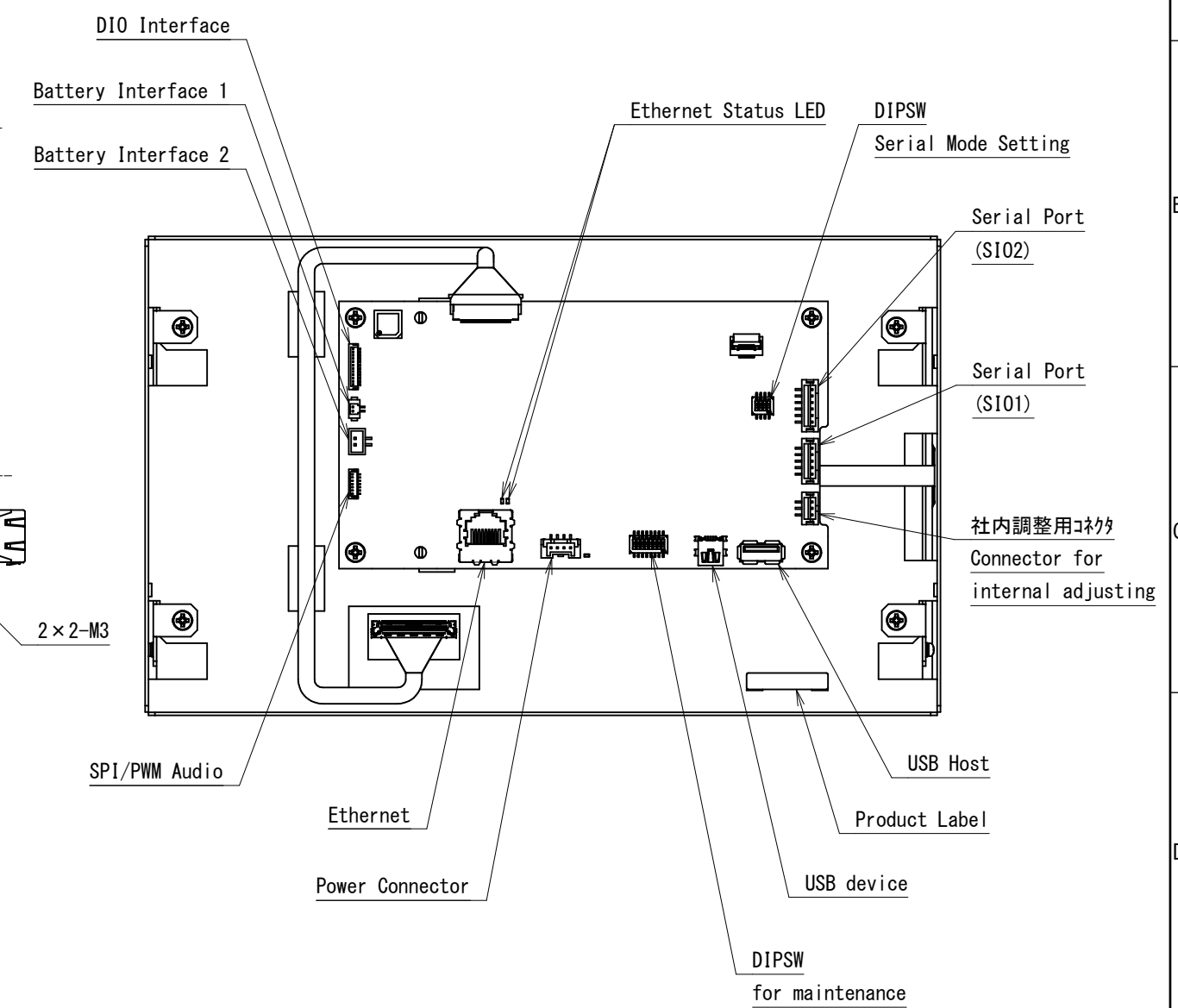
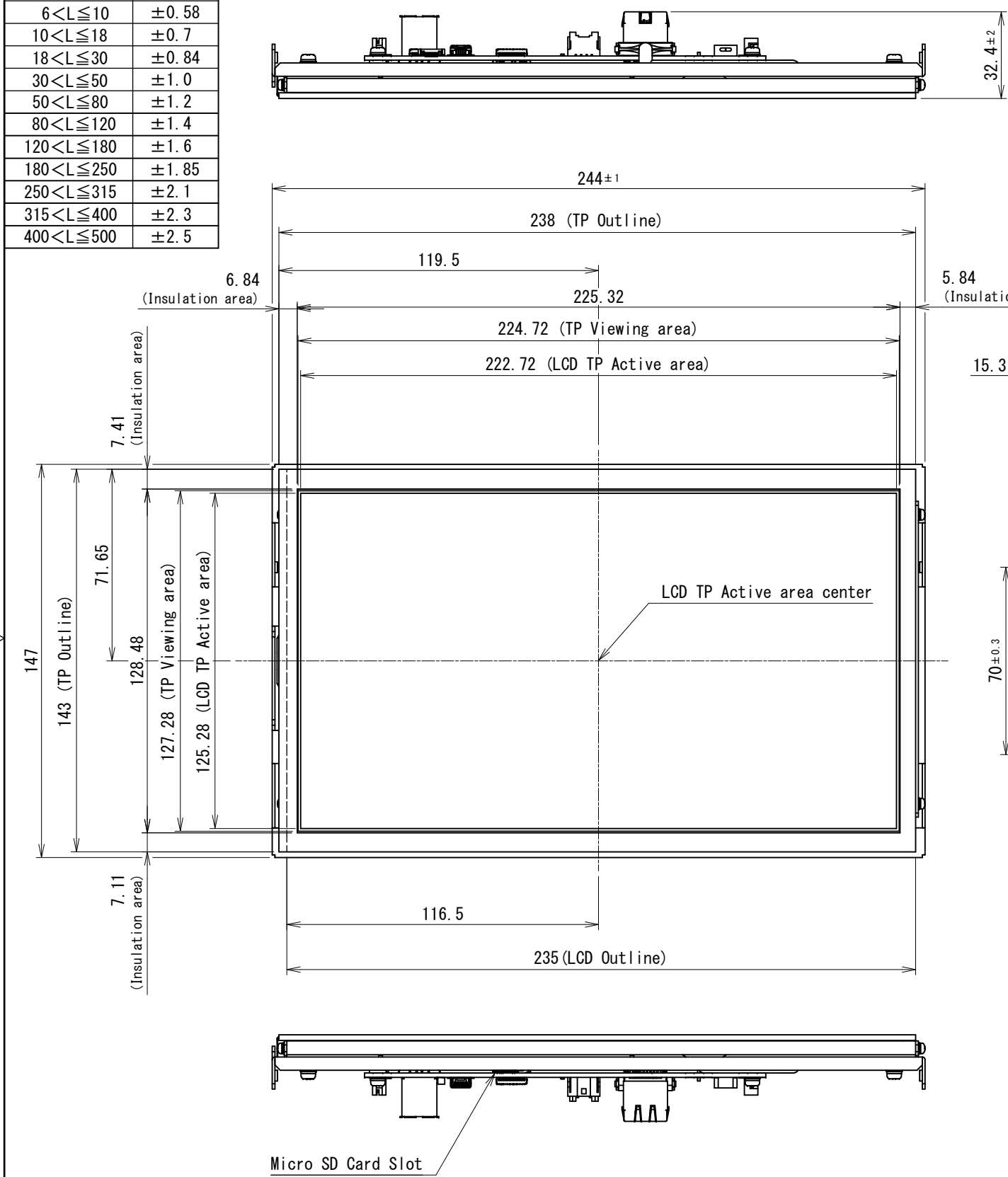

NOTES

- 指示なき寸法公差は一般寸法公差とする。
Tolerance shall be of general dimensional tolerance unless specified otherwise.
- 社内調整用コネクタは、お客様での使用はございません。
Connector for internal adjustment: cannot be used by customer.

製図日 ISSUED	2020.09.29	部署 SECTION	Technical Dept.	尺度 SCALE	CAD登録名 CAD FILE NAME	20K013-1_EM8-W310A7_OUTLINE	RoHS対応品 RoHS compliant
承認 APPROVED		検図 CHECKED		1:2	製品名 MODEL	EM8-W310A7-0024-XX7	
		製図 DRAWN	S. Takada	単位 UNIT	図名 TITLE	OUTLINE	ページ PAGE
T. Okada	S. Yoshimoto		S. Takada	mm			1 / 1
DMC Co., Ltd.			A3	図番 DWG No.	SM3-002153-10		

寸法公差表 (公差等級 IT15)	
呼び寸法 Nominal Dimensions	
L ≤ 3	±0.4
3 < L ≤ 6	±0.48
6 < L ≤ 10	±0.58
10 < L ≤ 18	±0.7
18 < L ≤ 30	±0.84
30 < L ≤ 50	±1.0
50 < L ≤ 80	±1.2
80 < L ≤ 120	±1.4
120 < L ≤ 180	±1.6
180 < L ≤ 250	±1.85
250 < L ≤ 315	±2.1
315 < L ≤ 400	±2.3
400 < L ≤ 500	±2.5

SYM	改訂日 DATE	改訂内容 DESCRIPTION	ページ PAGE	担当 DESIGNED
	2023.01.25	新規図面登録	—	M.Mitani

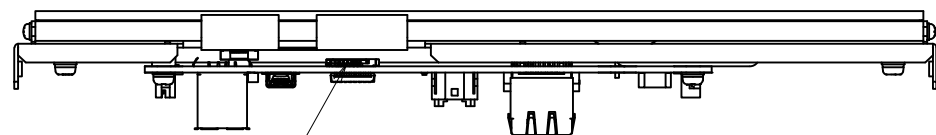
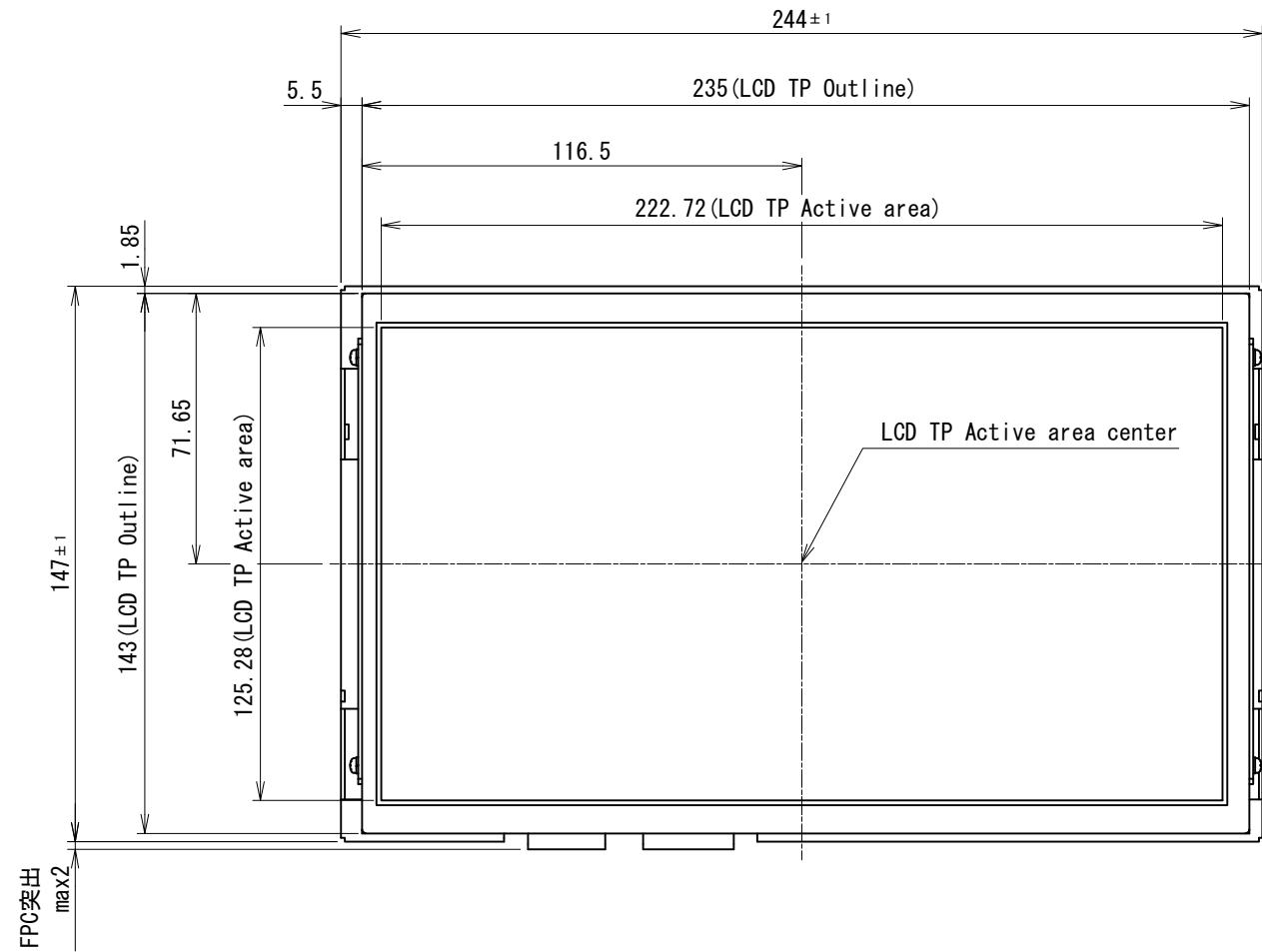
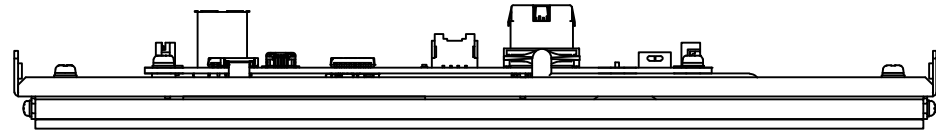

Micro SD Card Slot

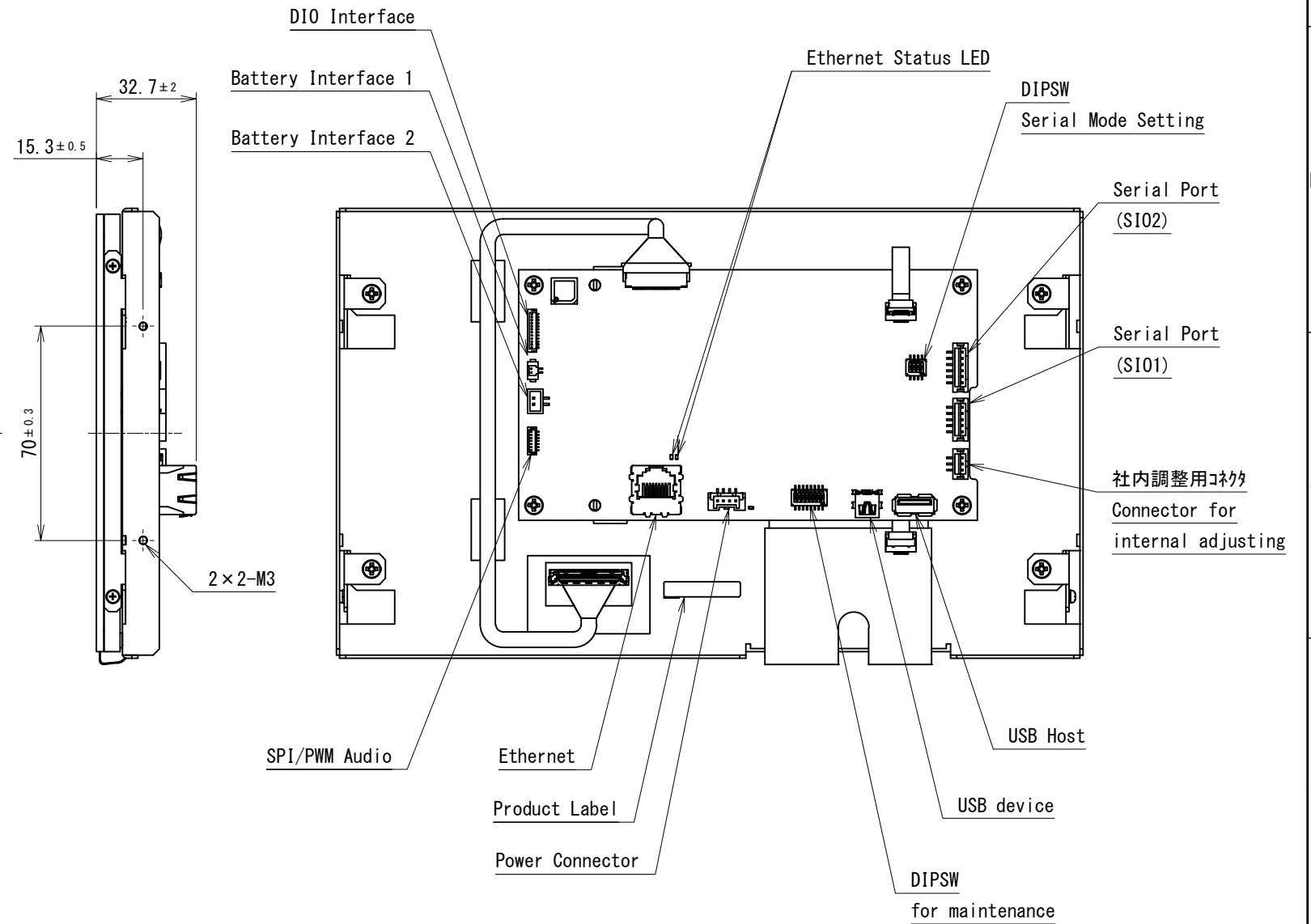

NOTES

- 指示なき寸法公差は一般寸法公差とする。
Tolerance shall be of general dimensional tolerance unless specified otherwise.
- 社内調整用コネクタは、お客様での使用はございません。
Connector for internal adjustment: cannot be used by customer.

製図日 ISSUED	2023.01.25	部署 SECTION	Technical Dept. <th>尺度 SCALE</th> <td>1:2 <th>CAD登録名 CAD FILE NAME</th> <td>22K003_OUTLINE_EMG8-W310A7</td> <th>RoHS対応品 RoHS compliant</th> <td></td> </td>	尺度 SCALE	1:2 <th>CAD登録名 CAD FILE NAME</th> <td>22K003_OUTLINE_EMG8-W310A7</td> <th>RoHS対応品 RoHS compliant</th> <td></td>	CAD登録名 CAD FILE NAME	22K003_OUTLINE_EMG8-W310A7	RoHS対応品 RoHS compliant	
承認 APPROVED	T.Okada	検図 CHECKED	S.Yoshimoto	単位 UNIT	mm	製品名 MODEL	EMG8-W310A7-0024-XX7	図名 TITLE	OUTLINE
製図 DRAWN	M.Mitani	設計 DESIGNED	M.Mitani	図番 DWG No.	SM3-002328-10	ページ PAGE		1 / 1	
DMC Co., Ltd.				A3					